

Walter F. MADDISON

Arthur Blake MADDISON
m. 29 May 1922, Lynn, Esse

Leonard MADDISON











Barbara Ann MADDISON

Frederick MADDISON

David MADDISON















Marian Louise NEWHALL

Leonard NEWHALL

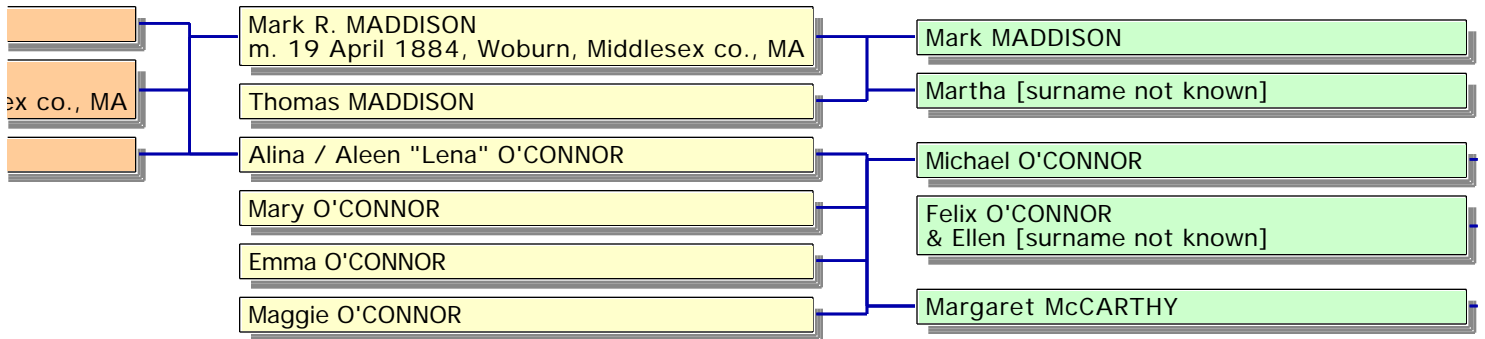

Oliver Nelson NEWHALL
m. 28 May 1833, Lynn, Essex co., MA

Allen NEWHALL Jr.
& Martha ADAMS
m. 15 June 1815, Lynn, Essex co., MA

Thomas Hanson NEWHALL

William H. B. NEWHALL

Mary NEWHALL

Otis NEWHALL

Lucy Jane NEWHALL

George Pickering NEWHALL

Alfred Augustus NEWHALL

John Wesley NEWHALL

Timothy NEWHALL

Levi Downing NEWHALL

Abby Marla NEWHALL

Lydia Ellen NEWHALL

Nelson Allen NEWHALL
& Hannah B. CARTER
m. 3 July 1857, Lynn, Essex co., MA

Mary Nichols NEWHALL

Charles Barker NEWHALL
& Margaret MORIARTY
mp. Lynn, Essex co., MA

John Henry NEWHALL

Alfred Augustus NEWHALL

Thomas Eugene NEWHALL

William Arthur NEWHALL
& Virginia SEGER
mp. Swampscott, Essex co., MA

Eva Eugenia NEWHALL
& Charles A. JENKINS
m. 19 May 1875, Lynn, Essex co., MA

Ellen Augusta NEWHALL
& Fred J. NEWHALL
m. 10 May 1881, Lynn, Essex co., MA

Henry Ernest NEWHALL
m. 8 April 1885, Lynn, Essex co., MA



Vertical line on the left side of the page.

Vertical line on the right side of the page.

Vertical line on the left side of the page.

Vertical line on the right side of the page.

Sally1 SWEETSER

Clarisse SWEETSER

Polly SWEETSER

Sally2 SWEETSER

Joseph SWEETSER

Hannah SWEETSER

Lydia Hawkes SWEETSER

Maria Augusta SWEETSER











David Johnson NEWHALL
m. 22 November 1848, Lynn, Essex co., MA

Vertical blue line on the left side of the page.

Vertical blue line on the right side of the page.

Mary Josephine NEWHALL

Abigail NEWHALL

Sarah NEWHALL

Sarah L. CARROLL
& Phillip P. TAPLEY
m. 19 October 1837, Lynn, Essex co., MA

Harriet Attwood CARROLL

Lydia Dean CARROLL

Auria Angelina CARROLL
& Erastus D. WARE
m. 8 December 1847, Lynn, Essex co., MA

Hannah Ellen CARROLL

Louisa Ann CARROLL

Edward Herbert CARROLL

Charles CARROLL

Adeline CARROLL

Lucy H. CARROLL

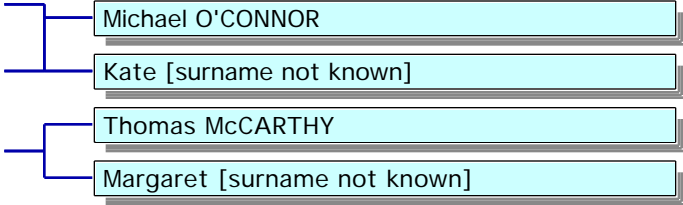

Hanson NEWHALL
m. 6 February 1765, Lynn, Essex co., MA

Ebenezer NEWHALL
& Hannah LARRABEE
& Martha [surname not known]

Timothy NEWHALL
& Lois HUTCHINS
m. 2 March 1794

Sally NEWHALL
& Timothy MUNROE
m. 11 April 1793

Jerusha NEWHALL
& Benjamin JOHNSON Jr.
m. 12 June 1790

Allen NEWHALL
m. 7 February 1793, Lynn, Essex co., MA

Joseph BREED
& Rebecca MERRIAM
m. 1 November 1750

Love BREED
& Allen NEWHALL
m. 29 March 1750

Jerusha BREED
& Henry BACHELLER
m. 4 April 1758

Huldah BREED
& Nehemiah LINDSEY

Abigail1 BREED

Abigail2 BREED
& Richard RICHARDS
m. 2 December 1761

Allen BREED
& Abigail LINDSEY
m. 4 March 1766

Hepzibah BREED

Eliphalet BREED
& Mary JOHNSON
m. 10 December 1772

Colonel Frederick BREED Esq.
& Sarah MANSFIELD

Nathaniel NEWHALL
& Rebecca HARWOOD

Abigail NEWHALL

Joseph NEWHALL
& Dorcas BARRETT
& Hannah NOURSE

David NEWHALL
& Sarah HARWOOD

Elizabeth NEWHALL
& William NEWHALL

Thomas NEWHALL
& Sally LEWIS

& Sally HUDSON

Jedediah NEWHALL
m. 17 November 1774, Lynn, Essex co., MA

Martha NEWHALL
& Ezekiel NEWHALL
m. 20 February 1777

Joshua NEWHALL
& Comfort CARRINGTON

Michal NEWHALL

Sally NEWHALL

Thomas NEWHALL

Nabby NEWHALL

Ruth NEWHALL

Betsy NEWHALL

Charlotte NEWHALL

Jedidiah NEWHALL Jr.
& Ann Eaton [surname not known]

Aaron NEWHALL
& Sally ALLEY
m. 17 October 1813, Lynn, Essex co., MA



Michal DOWNING

Elisabeth DOWNING,

John DOWNING,

Samuell DOWNING,

Susanna DOWNING,

James DOWNING,

Ruth DOWNING,

Sarah DOWNING,

Thomas DOWNING,

Samuel SWEETSER
m. 24 March 1757, Lynn, Essex co., MA

William SWEETSER

Michael1 SWEETSER

Michael2 SWEETSER

Mary SWEETSER

Martha SWEETSER

Paul SWEETSER

Sarah SWEETSER

Lydia SWEETSER

Cornelious SWEETSER

Abigal SWEETSER

Elisabeth SWEETSER

Samuel SWEETSER

John SWEETSER

James SWEETSER

Daniel SWEETSER

Joseph SWEETSER
m. 3 April 1787, Lynn, Essex co., MA

Asa SWEETSER

Ezra SWEETSER

Moses SWEETSER

Lydia SWEETSER

Aaron SWEETSER

Elias SWEETSER

Vertical line on the left side of the page.

Vertical line on the right side of the page.

Mary HAWKES

Hannah HAWKES

Rebecca1 HAWKES

Lydia HAWKES

Sarah HAWKES

Adam HAWKES

Rebecca2 HAWKES

John HAWKES

William CHEEVER

Sarah CHEEVER

Mary CHEEVER

Mary CHEEVER

Sarah CHEEVER

Rebecca CHEEVER

Reverend Ebenezer Giles CHEEVER

Lydia CHEEVER

David NEWHALL Jr.
m. 29 June 1766, Salem, Essex co., MA

Mary NEWHALL

Joseph NEWHALL Jr.
m. 21 December 1806, Salem, Essex co., MA

Hannah NEWHALL,

Ruth NEWHALL,

Hepzibah NEWHALL

Dorcas NEWHALL,

Mary NEWHALL

David NEWHALL

Mary JOHNSON

Hezekiah DUNKLEE
m. 6 December 1757, Danvers, Essex co., MA [intention

Nathaniel DUNKLEE

Damaris DUNKLEE

Hezekiah DUNKLEE

Ezekiel DUNKLEE
& Rebekah STANDLY
m. 13 July 1783, Danvers, Essex co., MA

Sally DUNKLEE

Ebenezer DUNKLEE

Deliverance DUNKLEE

John DUNKLEE

Seth DUNKLEE

Betty/Betsey DUNKLEE
& Ebenezer TWISS
m. 31 August 1800, Danvers, Essex co., MA

Hannah DUNKLEE
& Francis PHELPS
m. 1 May 1802, Danvers, Essex co., MA

Alice DUNKLEE
& Zacheus CHURCHILL
m. 19 February 1799, Danvers, Essex co., MA

Katherine MARSH

Humphrey MARSH,

Ebenezer MARSH,

Caleb MARSH

Captain Edward CARROLL
m. 5 April 1818, Lynn, Essex co., MA

Samuell CARROLL

Sarah [surname not known]



Enoch1 MOWER

Lydia MOWER
& Jabez BREED
m. 15 April 1778, Lynn, Essex co., MA
& John PRATT

Alice MOWER
& Samuel CHASE

m. 27d:9m:1780, Lynn, Essex co., MA

Abigail MOWER
& Samuel BLAKE
m. 11d:4m:1783, Lynn, Essex co., MA

Elizabeth MOWER
& Benjamin Hood PHILLIPS
m. before 1784, Lynn, Essex co., MA

Enoch2 MOWER
& Lydia NEWHALL
m. 21d:9m:1791, Lynn, Essex co., MA

Mary MOWER
& Jonathon PHILLIPS Jr.
m. 20d:9m:1792, Lynn, Essex co., MA

Martha MOWER
& Enoch BREED

John MOWER III
m. 11 January 1795, Lynn, Essex co., MA

Nathan MOWER
& Huldah WINSLOW
& Lydia NEAL

[unnamed child] MOWER

Hannah MOWER

[unnamed child] MOWER



William Scales WOODMAN

Abigail WOODMAN

Hannah WOODMAN

Elizbaeth WOODMAN

Alexander WOODMAN

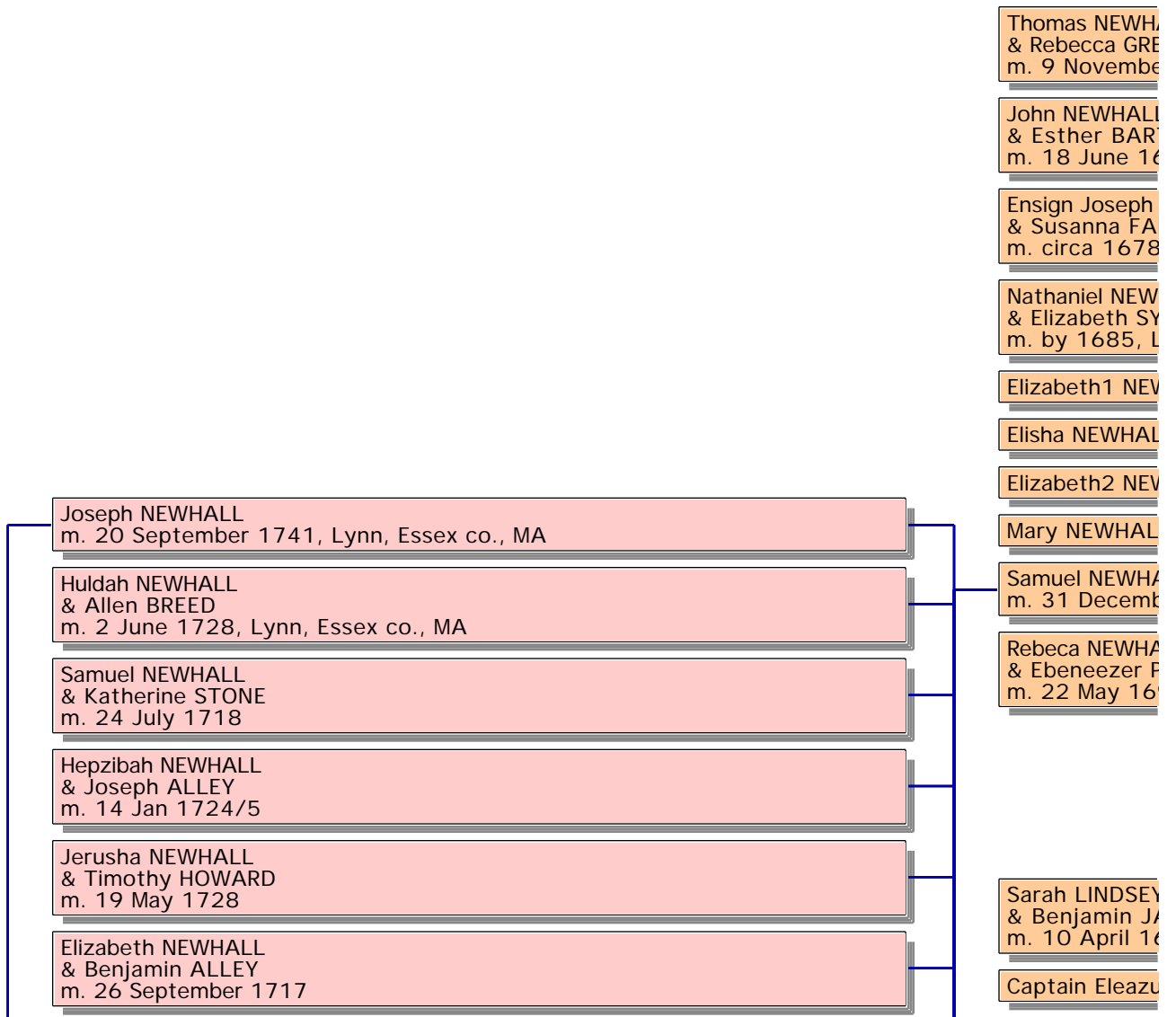

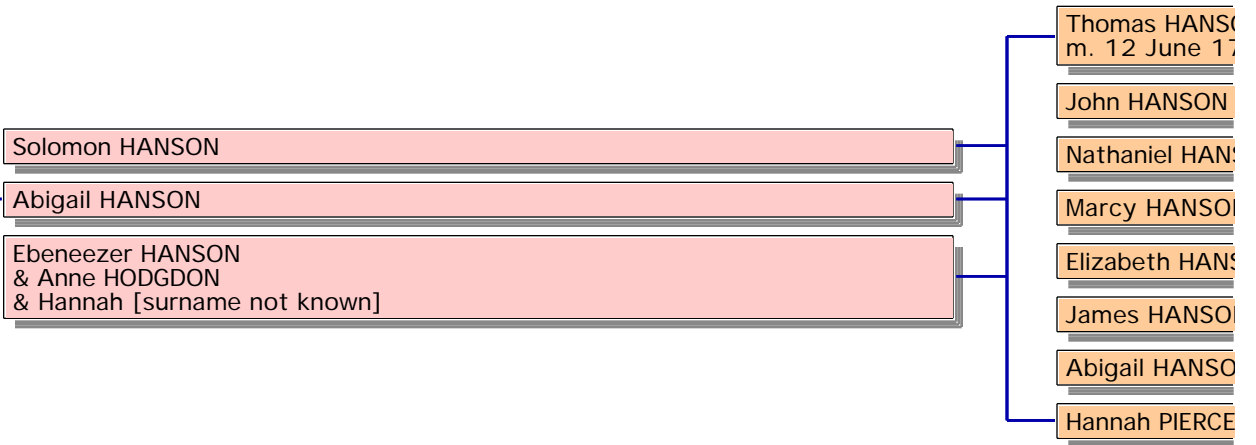
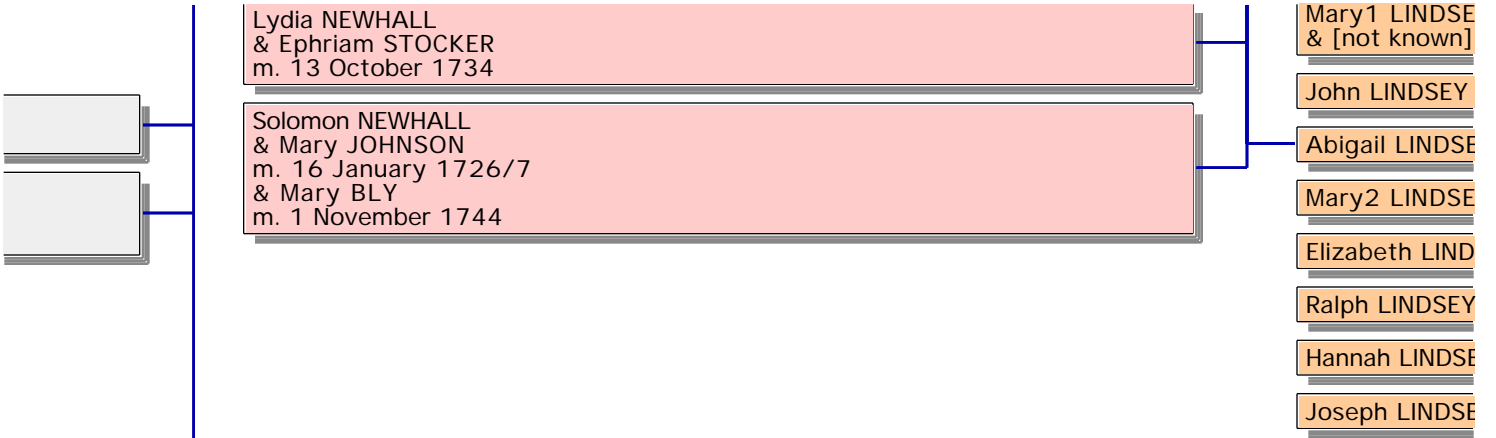

Timothy BREE
& Sarah BRAN
m. after 27 Nc

& Sarah NEWH
m. 3 Mar 167

Ensign Joseph
m. 27 Septem

Allen BREED
& Elizabeth BA
m. 22d:3m:16

Captain John E
& Mercy PALM

Mary BREED
& Thomas LEV

Elizabeth BREE
& Thomas BUF

Samuel BREED
& Anna HOOD
m. 5 February

Mary BREED
& Ralph LINDSEY

Jane BREED
& Captain Elisha NEWHALL
m. 27 Feb 1710/11

Sarah BREED
& Andrew MANSFIELD

Joseph BREED
& Susanna NEWHALL
m. 16 July 1717

Ruth BREED

Elizabeth BREED
& Ensign Ebenezer NEWHALL
m. 8 November 1718

Matthew1 BREED

Matthew2 BREED
& Mary STOCKER

Mercy BREED
& Robert POTTER

Mehitable BREED
& Jacob EATON

Allen BREED
m. 2 June 1728, Lynn, Essex co., MA

Mathew FARRI
& Sarah POTT
m. 28 April 16
& Mary NEWH,
m. before 168

Sarah1 FARRIN

William FARRIN

Sarah2 FARRIN

Theophilus FA

Probably Job

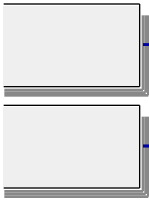

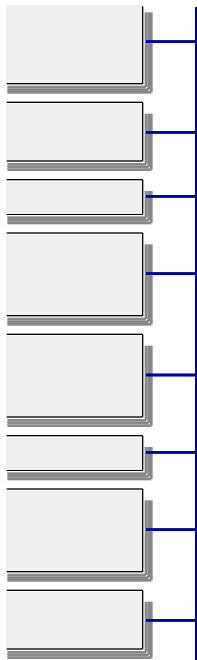

Probably John
& Lydia HUDSON

Thomas NEWHALL
& Rebecca GREENE
m. 9 November 1678

John NEWHALL
& Esther BARKER
m. 18 June 1678

Ensign Joseph
& Susanna FARMER
m. circa 1678

Nathaniel NEWHALL
& Elizabeth SYMONS
m. by 1685, L

Elizabeth1 NEWHALL

Elisha NEWHALL

Elizabeth2 NEWHALL

Mary NEWHALL

Samuel NEWHALL
m. 31 December 1678

Rebecca NEWHALL
& Ebenezer FARMER
m. 22 May 1678

Joseph NEWHALL
& Abigail HANSON
m. 20 September 1741, Lynn, Essex co., MA

Huldah NEWHALL

Samuel NEWHALL
& Katherine STONE
m. 24 July 1718

Hepzibah NEWHALL
& Joseph ALLEY
m. 14 Jan 1724/5

Jerusha NEWHALL
& Timothy HOWARD
m. 19 May 1728

Elizabeth NEWHALL
& Benjamin ALLEY
m. 26 September 1717

Lydia NEWHALL
& Ephriam STOCKER
m. 13 October 1734

Solomon NEWHALL
& Mary JOHNSON
m. 16 January 1726/7
& Mary BLY
m. 1 November 1744

Sarah LINDSEY
& Benjamin JOHNSON
m. 10 April 1678

Captain Eleazar LINDSEY

Mary1 LINDSEY
& [not known]

John LINDSEY

Abigail LINDSEY

Mary2 LINDSEY

Elizabeth LINDSEY

Ralph LINDSEY

Hannah LINDSEY

Joseph LINDSEY

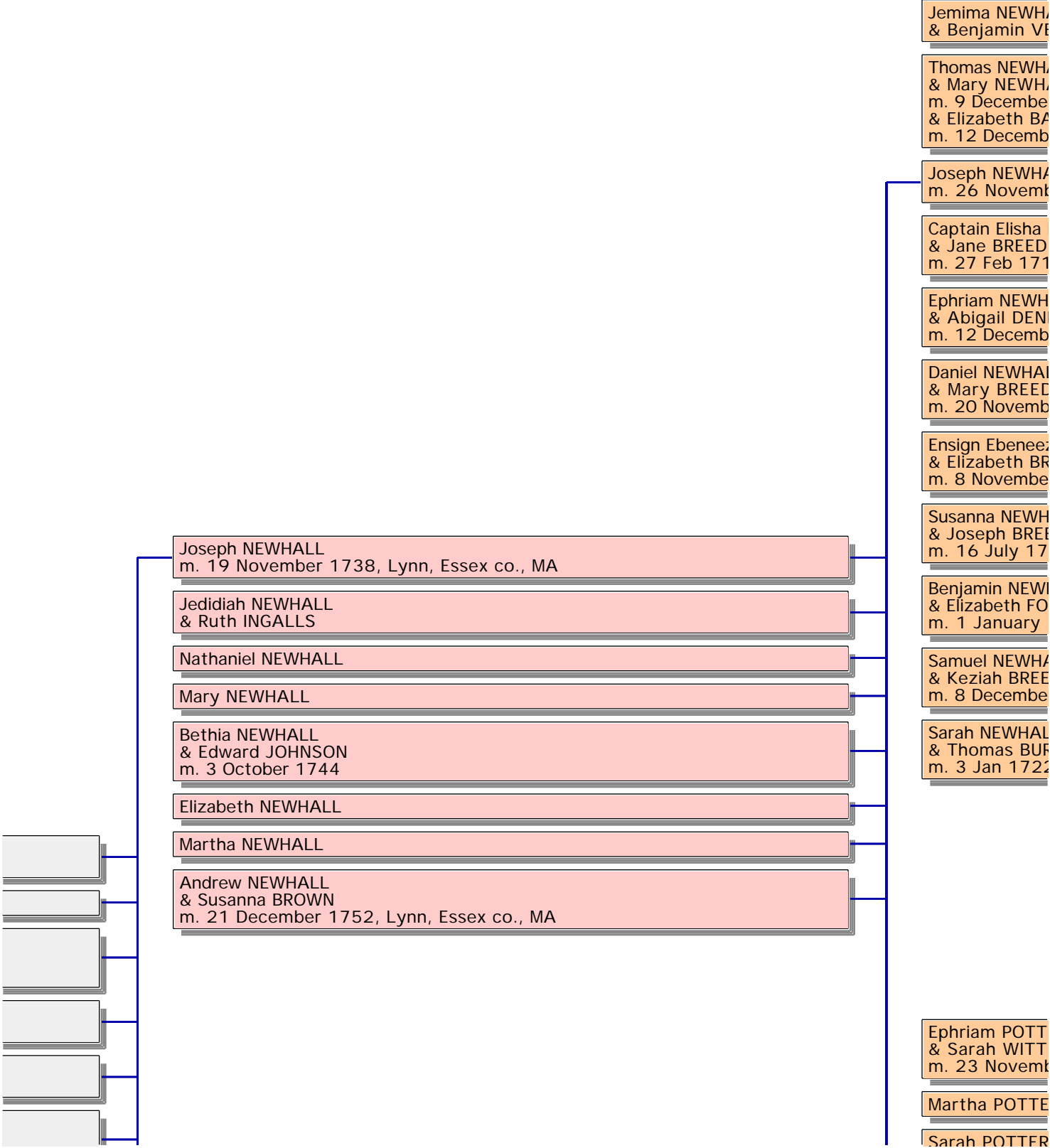

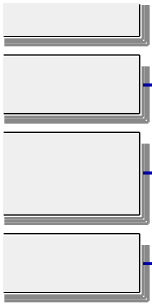

- Sarah POTTER & Thomas BU...
- Ruth1 POTTER
- Ruth2 POTTER & Nathaniel CC
- Elizabeth POT...
- Robert POTTEI & Marcy BREE m. 29 Novemb
- Rebecca POTTI & Jonathon CC
- Mary POTTER
- Nathaniel POT

Elizabeth HODGMAN

Josiah HODGMAN & Rebecca BUSS m. 16 April 1745, Concord, Middlesex co., MA & Dorothy WHEELER m. 31 May 1749, Concord, Middlesex co., MA

Benjamin HODGMAN & Elizabeth MERIAM

Jonathon HODGMAN & Mary (Mercy) BUTTRICK

Thomas HODGMAN & Elizabeth BILOOD

David HODGMAN

Timothy HODGMAN & Ann LEE

John HODGMAN & Lois PARLING

Thomas HODGI m. 19 January

James GEARY & Sarah [surnam

John GEARY & Elizabeth W

Benjamin GEA & Elizabeth DA

Abigail GEARY

Thomas GEARY & Abigail WYM

Caleb DOWNING m. 2 Mar 172

Captain Caleb DOWNING m. 16 May 1751, Lynn, Essex co., MA

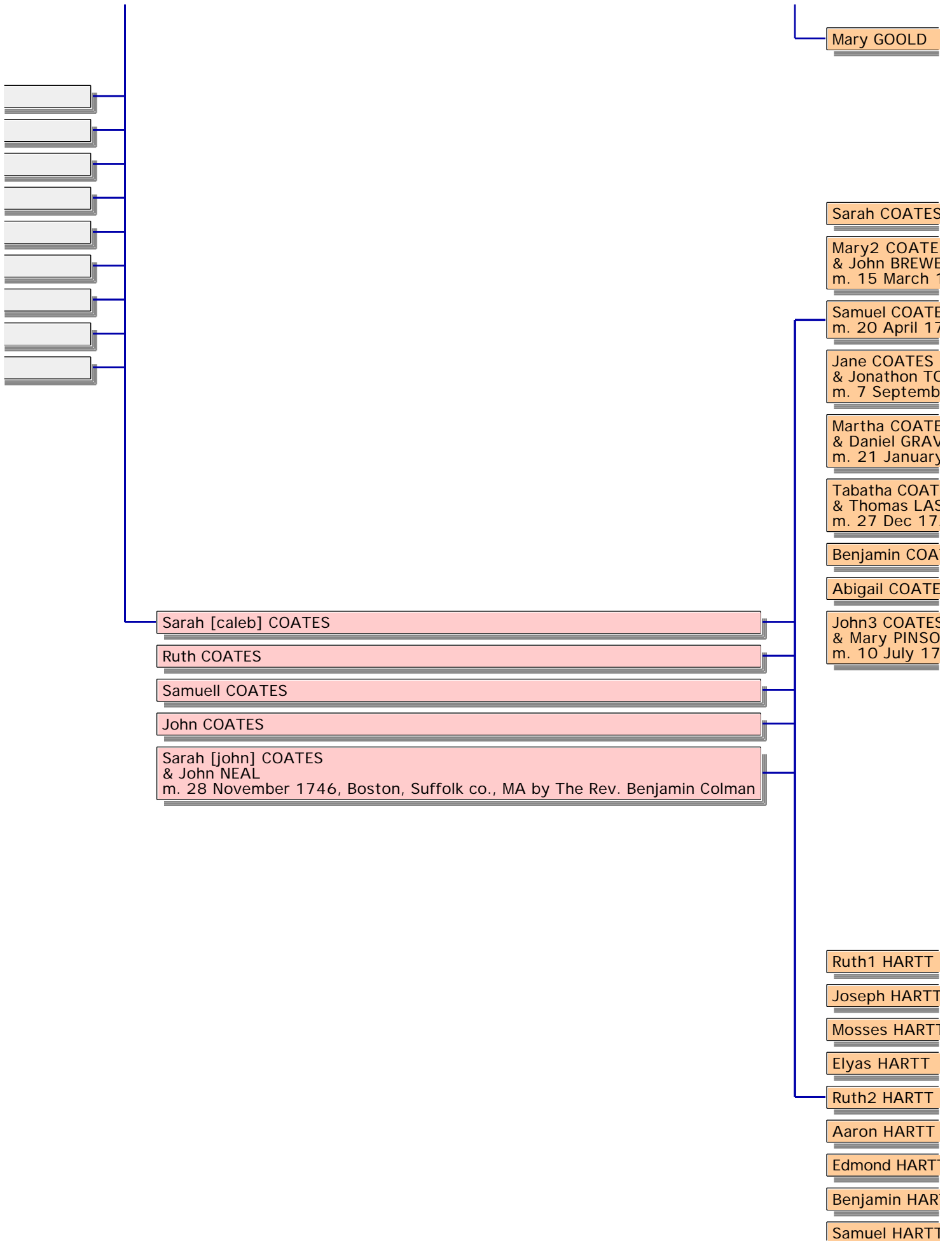

Abigail SWEET
& Andrew STI
m. 1678, Cha
& Andrew STE
m. 9d:1m:167

Bethia SWEET
& Edward PAI
& Isaac WHEEL

Benjamin SWE

Seth SWEETSE

Joseph SWEET

Samuel SWEET
m. circa 1697

Wigglesworth

Elizabeth SWEETSER
& Samuel TUFTS

Abigail SWEETSER

Samuel SWEETSER

John SWEETSER

Jacob SWEETSER

Michael SWEETSER
m. 18 November 1731, Malden, Middlesex co., MA

Joseph SWEETSER

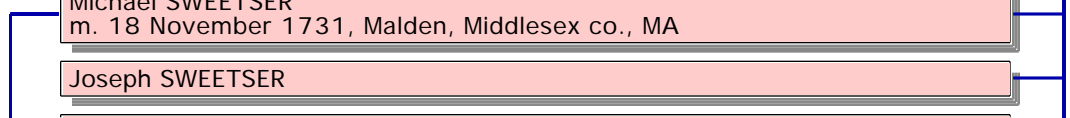

Lydia SWEETSER
& Daniel MERRITT

Stephen SWEETSER

Mary SWEETSER

John SPRAGUE

Stower SPRAGUE

Abiah SPRAGUE
& W. BODMAN

Mary SPRAGUE
& Nathaniel TULLY

Elizabeth SPRAGUE

Hannah SPRAGUE

[Redacted]

[Redacted]

[Redacted]

[Redacted]

[Redacted]

[Redacted]

[Redacted]

[Redacted]

[Redacted]

[Redacted]

[Redacted]

[Redacted]

John SMITH

Isaac SMITH
m. 22 Novemb

Abraham SMITH

James SMITH

Catherine SMITH
& Samuel FELTON
m. 6 May 171

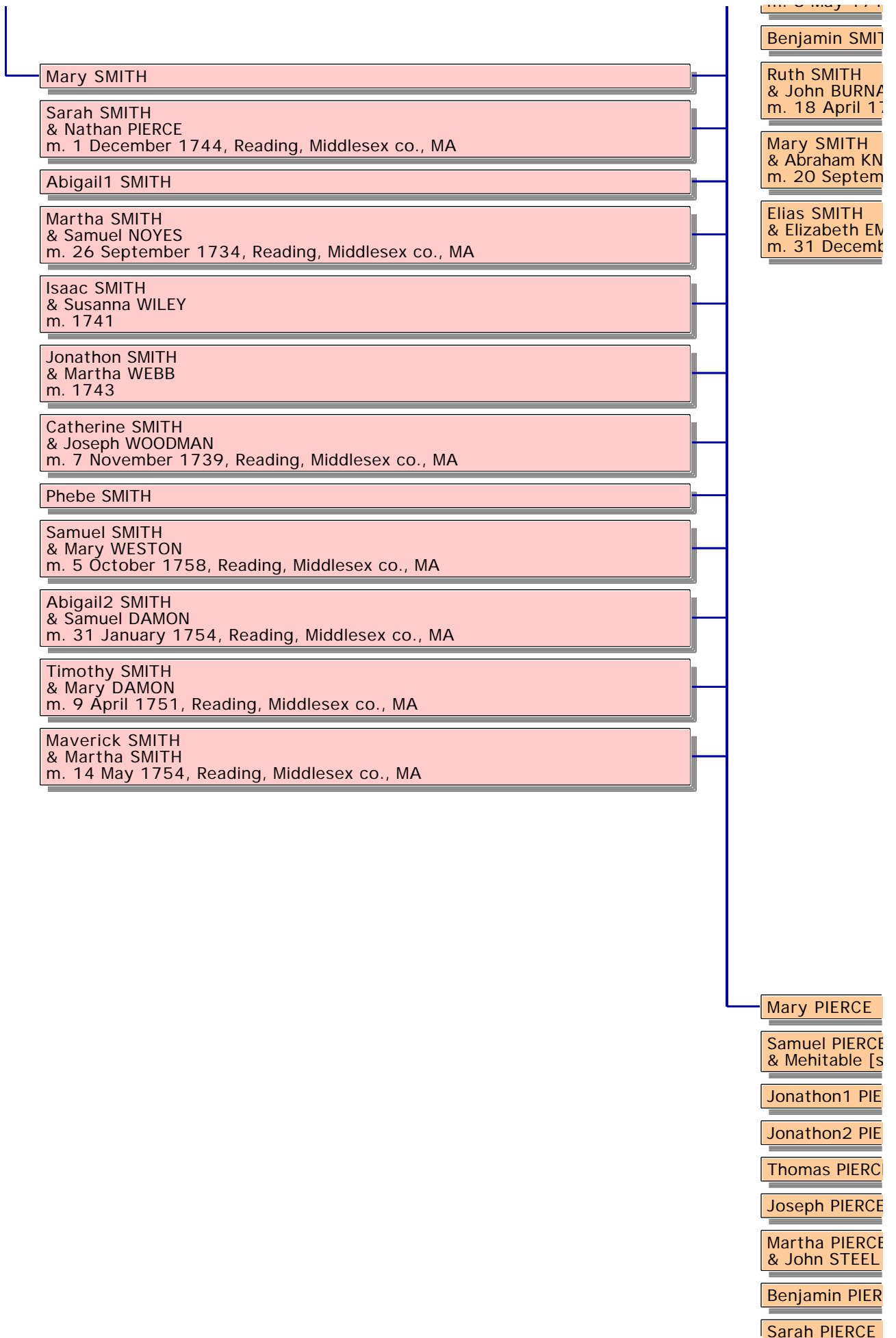

Elizabeth PIERCE
& Abraham SMITH

Isaac PIERCE

John PIERCE

Jacob PIERCE

Stephen PIERCE

Moses HAWKE
m. 10 May 16



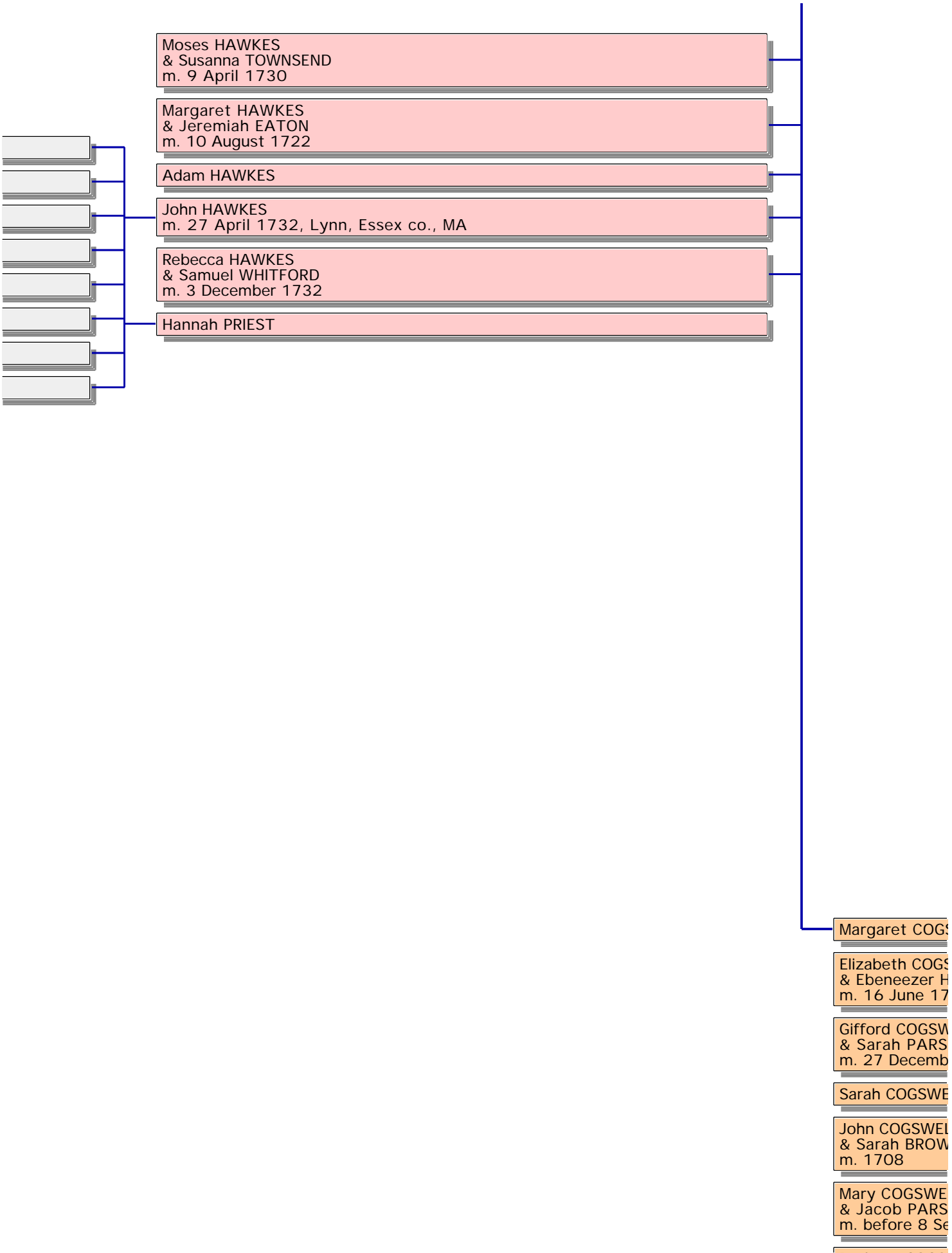

Bethany COGS
& Samuel GOT
m. 22 July 17

Susanna COGS
& Jeremiah P
m. 14 Decemb

Samuel COGS
& Mary LUFKII
m. 1723

Thomas CHEE
m. 11 Februar

Sarah CHEEVE
& Thomas KEN
m. 7 Novembe

Joshua CHEEVI
& Sarah WARF
m. 2 Novembe
& Sarah SEAR

Abigail1 CHEE

Abigail2 CHEE
& John BURT
m. 3 June 171

Ezekiel CHEEVI
& Elizabeth JE
& Elizabeth GI
m. 25 Septeml
& Sarah MOUS
m. 11 Novemb

Nathan CHEEVI
& Hannah BRO
m. 8 Novembe
& Anna BURRI

Mary1 CHEEVER

Thomas CHEEVER
& Eunice IVORY
m. 5 March 1729/30, Lynn, Essex co., MA

William CHEEVER
m. 20 January 1727/8, Lynn, Essex co., MA

Abner1 CHEEVER

William BOARI
& Abiah SPRA
m. 17 May 17

Lydia BOARDM
& Kendal PEAF
m. 30 March 1

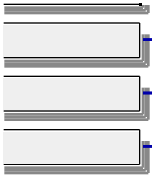

Mary BOARDM

Sarah WAITE
Abigail WAITE

William WAITE
Samuel WAITE
Mehetabel WA
& John (or An
Tabitha WAITE
& William PAI
Jabez WAITE
Sarah WAITE
& Jonathon TU
Mary WAITE
& John HUTCH
Edward WAITE

Mary LYNDE
& Jonathan SA
m. 13 March 1
Elizabeth LYND
& Nathaniel W
John LYNDE
Thomas LYNDE
Ann LYNDE
Abigail LYNDE
Samuel LYNDE

Eliazer GILES
& Rebecca CHAPMAN
m. 25 October 1730, Beverly, Essex co., MA

Lidia GILES
& Benjamin VERRY Jr.
m. 15 June 1728, Salem, Essex co., MA

John GILES
& Martha PITMAN
m. 25 September 1730, Beverly, Essex co., MA

Ebenezer GILES
m. 7 August 1739, Lynn, Essex co., MA

Samuel GILES
& Eunes HERRICK
m. 23 November 1747, Beverly, Essex co., MA

James GILES
& Hannah THOMPSON
m. 16 November 1749, Ipswich, Essex co., MA

Edmond GILES
& Esther ELLINWOOD
m. 9 July 1744, Beverly, Essex co., MA

Eleazor GILES
m. 24 April 17

Bridgett GILES

Ruth GROVER

Edmund GROVE

Mary GROVER

William GROVE

Lidia GROVER

Nehemiah GRO

Josiah GROVE

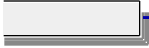

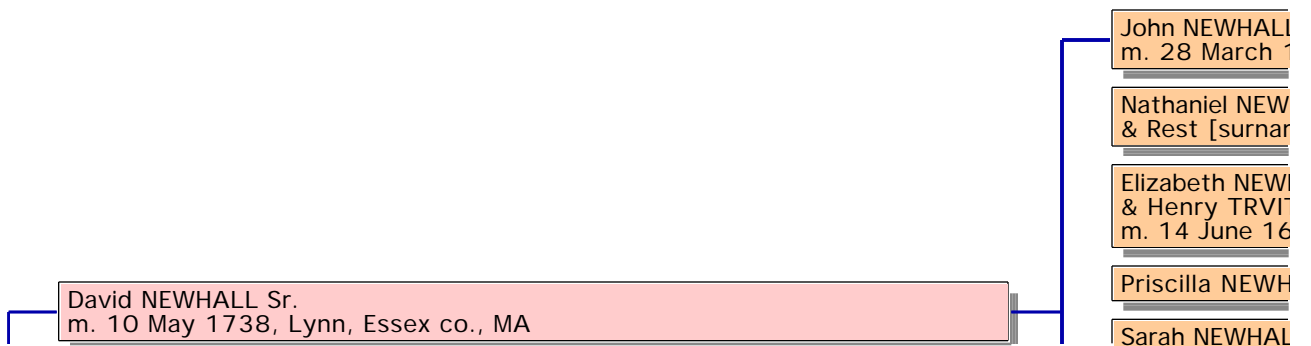
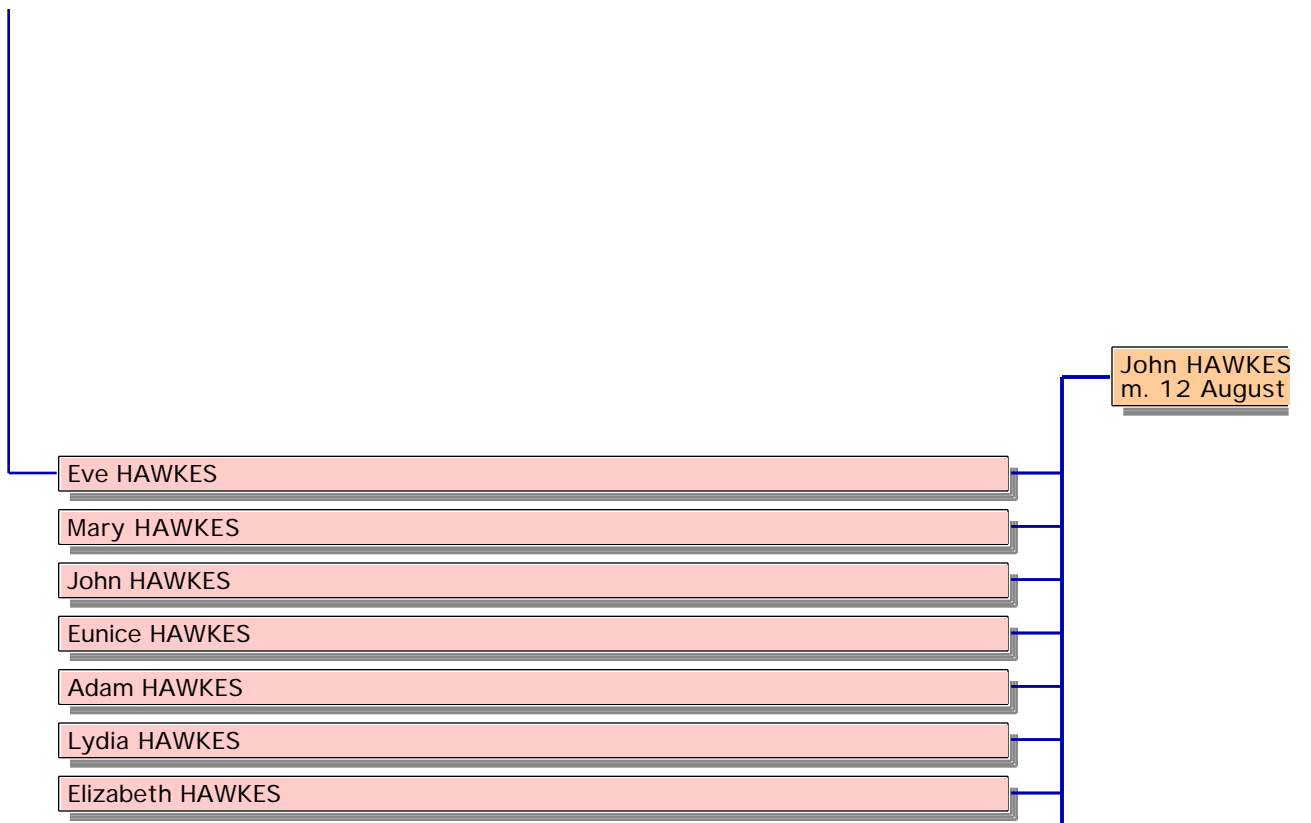

John NEWHALL
& Lydia SCADLET
m. 7 Jan 1719/20

Sarah NEWHALL

Henry NEWHALL
& Susanna SWIFT
m. 22 November 1722, Boston, Suffolk co., MA

Nathaniel NEWHALL

Eleazer NEWHALL
& Mary GRICE

Increase NEWHALL

& Timothy BRI
m. 3 Mar 1679

Mary NEWHALL

Rebecca NEWH
& Eleazer COL

Henry COLLINS
& Hannah LAM
m. 3 January
& Sarah HEIRE
m. 24 June 16

Hannah COLLIN

John COLLINS

Sarah COLLINS

Rebecca COLLI

Eleazer COLLIN

[Empty box]

[Empty box]

John Henery1 BURCHSTED

Mary BURCHSTED

Dr. Henry BURCHSTED
& Anna [surname not known]

Dr. Henry BUR
m. 1713, Bost

John BURCHST

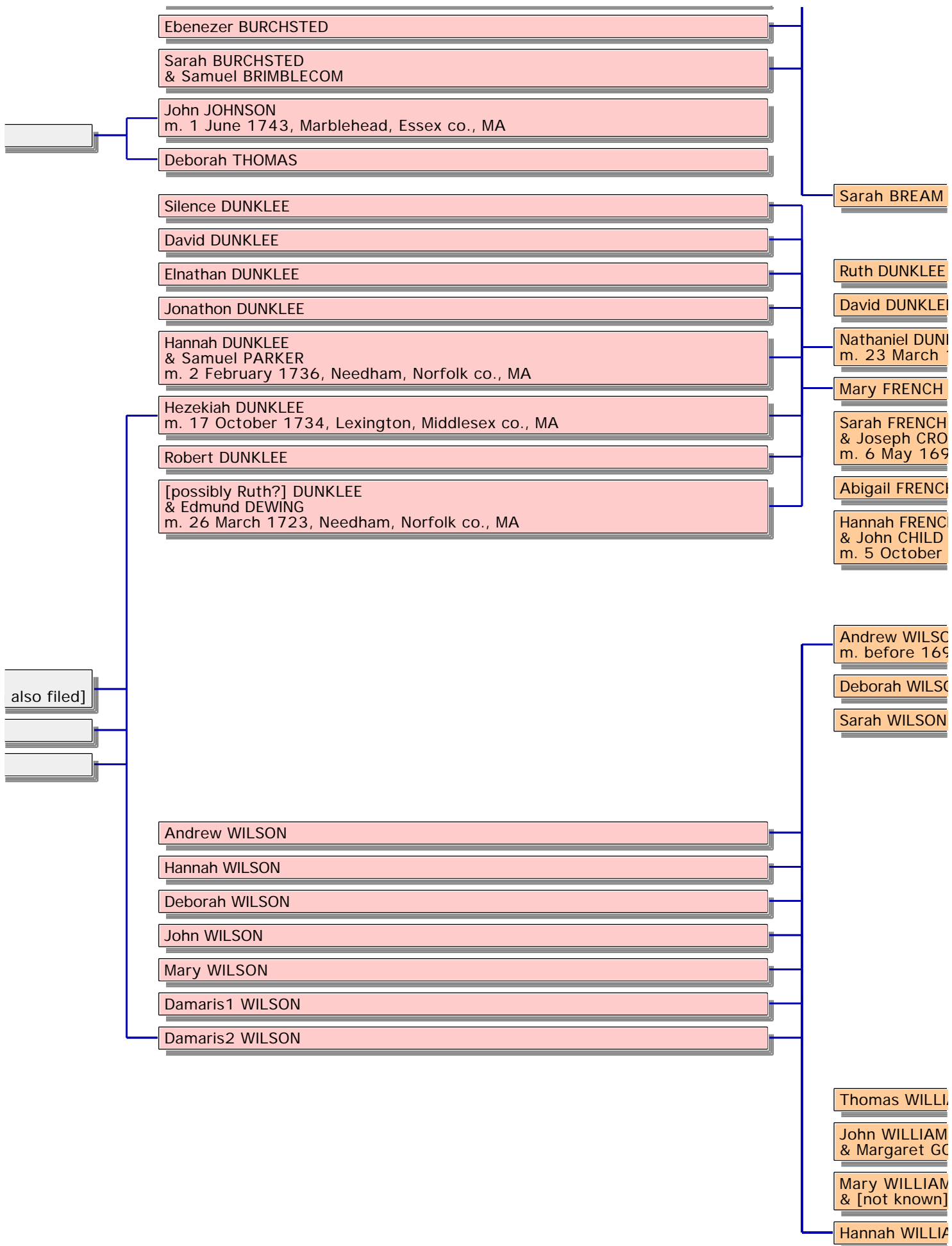

Stephen WILLI

John MARSH

Mary MARSH
& Ebenezer C

Zachariah MARSH

Elizabeth MARSH

Jonathan MARSH
& Mary VERRY

Ebenezer MARSH
m. 25 Novemb

Ezekiel MARSH

Abigail MARSH

Benjamin MARSH

Ebenezer MARSH Jr.
m. 13 September 1725, Salem, Essex co., MA

Lydia MARSH

Benjamin MARSH

George BOOTH
& Elizabeth [sister]
m. last of Jun

Elizabeth BOOTH
& Israel SHAW
m. 26 Decemb

Alice BOOTH

Benjamin BOOTH

Bridget BOOTH

Mary BOOTH

Rebecca BOOTH

Susanna BOOTH

Zachariah BOOTH

Abigaile1 FRENCH

Mary1 FRENCH

Abigaile2 FRENCH



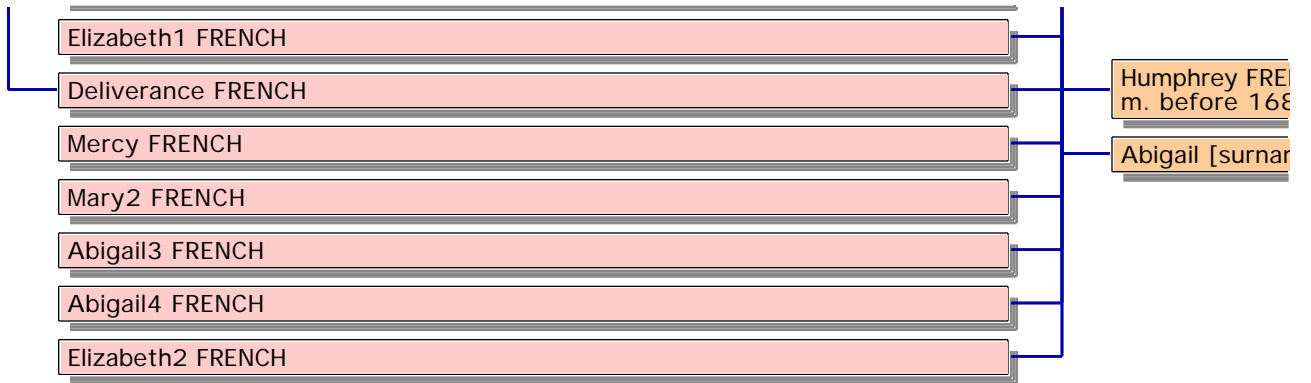

Thankful MOW
& James PICK
m. 7 January

John MOWER S
m. 10 August

Ezra MOWER
& Lydia BURRI
m. 20 October

Captain Richar
& Lois [surnar

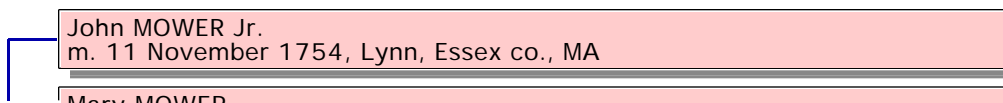

Mary MOWER
& Nathan GIFFORD
m. 1767

Ebenezer MOWER

Richard MOWER

Ebenezer BU

John BURRILL

Martha BURRILL

Theophilus BU

Mary BURRILL

Eunice BURRILL

Lois BURRILL

Samuel BURRILL

Sarah BURRILL

Lydia BURRILL
& Ezra MOWER
m. 20 October

[Redacted]

[Redacted]

[Redacted]



- Samuell BREED
- Amos BREED
- Jabez BREED
- Abigaile BREED
- Nathan BREED
m. 28 October
- Keziah BREED
& Samuel NEW
m. 8 December
- Anna BREED
- Ebenezer BREED
- Ruth BREED
- Benjamin BREED

Hannah1 BREED

Hannah2 BREED

Ezra BREED
& Huldah BREED

Abigail BREED
& Nehemiah BREED

Zephaniah BREED
& Ruth PHILLIPS
& Abigail COLLINS

John BREED

Daniel BREED
& Elizabeth PHILLIPS

Alice BREED
& William GRAY
& Ezra NEWHALL, Colonel

Anna BREED
& Ezra BURRILL

Mary BREED
& Phillips SAWYER

Enoch BREED



Desire BASSET

Zaphania BASS

Mary BASSET

Isaiah BASSET

Lydia BASSET

Daniel BASSET

Elizabeth WOO

John WOODMA

Samuel WOODI

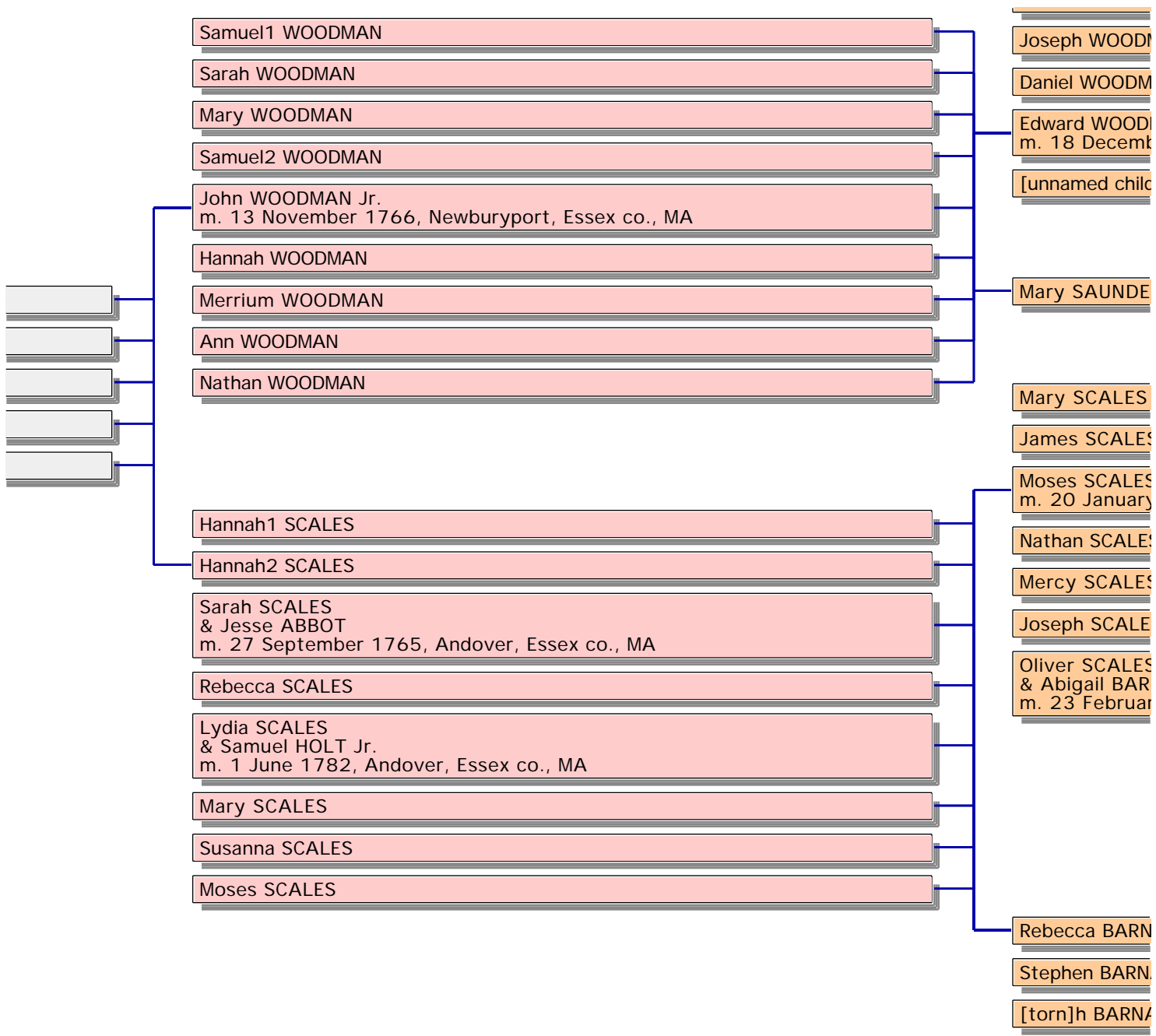

ALL
ENE
er 1674, Malden or Charlestown

L 3rd
TRAM
577, Lynn, Essex co., MA

NEWHALL
RRAR
, Lynn, Essex co., MA

HALL
MONDS
Lynn, Essex co., MA

VHALL

.L

VHALL

L

ALL
ber 1695, Lynn, Essex co., MA

ALL
PARKER
97

/
AMES
590, Lynn, Essex co., MA

ir LINDSEY

Susanna NEWHALL
& Richard HAVEN

Thomas NEWHALL
m. 29d:10m (December):1652, Lynn, Esse

Mary NEWHALL
& Thomas BROWN

Francis NEWHALL

John NEWHALL
& Elizabeth LAIGHTON
m. 3d:12m (February):1657, Lynn, Essex
& Sarah FLANDERS
m. 17 July 1679, Lynn, Essex co., MA

Elizabeth POTTER

Captain Robert POTTER
& [not known] [surname not known]
m. before 1657, Lynn, Essex co., MA
& Ruth DRIVER
m. 25d:11m(November):1659, Lynn, Esse

Samuel POTTER

Coronet Eleazer LINDSEY
m. August 1668, Lynn, Essex co., MA

John LINDSEY
& Mary ALLEY
m. 6 June 1667, Lynn, Essex co., MA
& Amy GRAVES

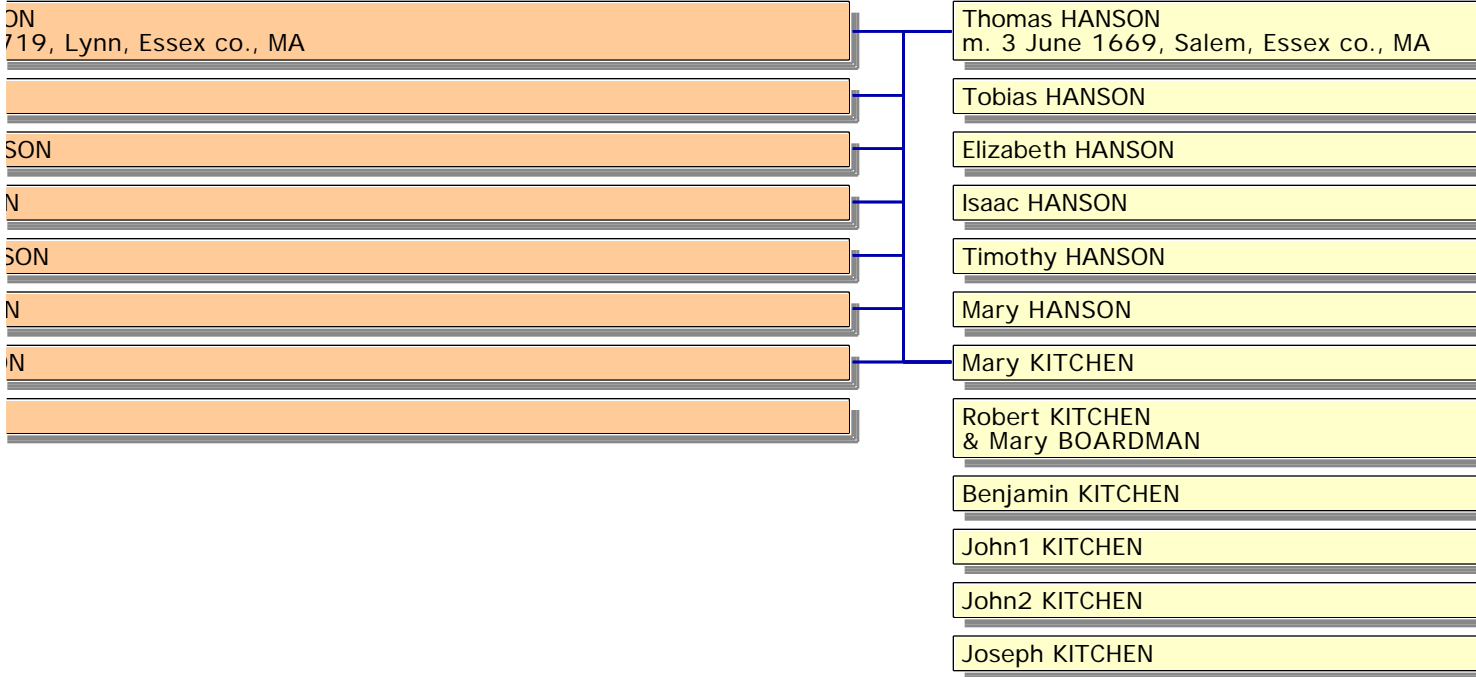
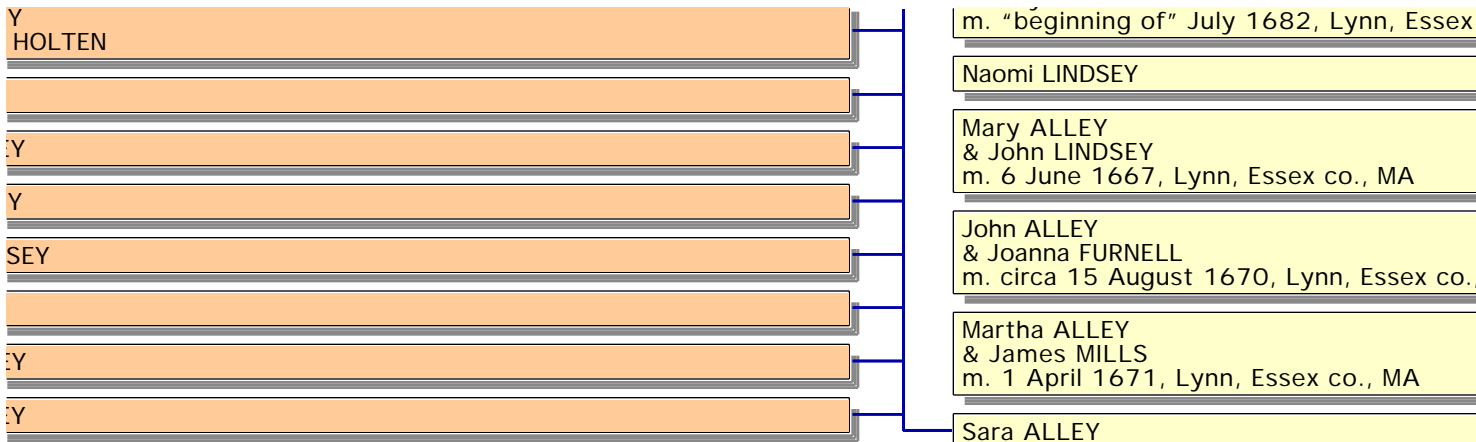

ON
November 1688

ALL
9/80

BREED
ber 1683, Lynn, Essex co., MA

ALLARD
84, Lynn, Essex co., MA

BREED
MER

VIS

D
RAGE

1691/2, Lynn, Essex co., MA

Mary SARGENT

Sarah SARGENT

Edward FARRINGTON
& Dorothy BROWNE

Thomas FARRINGTON
& Helena APPELEGATE

Sarah FARRINGTON
& Robert TERRY

Mathew FARRINGTON Sr.
m. 1648, Lynn, Essex co., MA

Joseph FARRINGTON

John FARRINGTON
& Elizabeth KNIGHT

Martha FARRINGTON

Elizabeth FARRINGTON
& John FULLER

NGTON Jr.
ER
575, Lynn, Essex co., MA
ALL
9, Flushing, Long Island, NY

NGTON

NGTON

NGTON

RRINGTON

51 FARRINGTON

J FARRINGTON
DN

Elizabeth SISLEY

ALL
ENE
er 1674, Malden or Charlestown

Susanna NEWHALL
& Richard HAVEN

L 3rd
TRAM
577, Lynn, Essex co., MA

Thomas NEWHALL
m. 29d:10m (December):1652, Lynn, Esse

NEWHALL
RRAR
, Lynn, Essex co., MA

Mary NEWHALL
& Thomas BROWN

HALL
MONDS
Lynn, Essex co., MA

Francis NEWHALL

VHALL

John NEWHALL
& Elizabeth LAIGHTON
m. 3d:12m (February):1657, Lynn, Essex
& Sarah FLANDERS
m. 17 July 1679, Lynn, Essex co., MA

L

VHALL

L

ALL
ber 1695, Lynn, Essex co., MA

Elizabeth POTTER

ALL
PARKER
97

Captain Robert POTTER
& [not known] [surname not known]
m. before 1657, Lynn, Essex co., MA
& Ruth DRIVER
m. 25d:11m(November):1659, Lynn, Esse

Samuel POTTER

/
AMES
590, Lynn, Essex co., MA

Coronet Eleazer LINDSEY
m. August 1668, Lynn, Essex co., MA

ir LINDSEY

John LINDSEY
& Mary ALLEY
m. 6 June 1667, Lynn, Essex co., MA
& Amy GRAVES
m. "beginning of" July 1682, Lynn, Essex

Y
HOLTEN

Naomi LINDSEY

Y

Mary ALLEY
& John LINDSEY
m. 6 June 1667, Lynn, Essex co., MA

Y

SEY

John ALLEY
& Joanna FURNELL
m. circa 15 August 1670, Lynn, Essex co.,

EY

Martha ALLEY
& James MILLS
m. 1 April 1671, Lynn, Essex co., MA

EY

Sara ALLEY

ALL
ERY

ALL
ALL
r 1707
NCROFT
er 1717

ALL Senior
ber 1713, Lynn, Essex co., MA

NEWHALL
O/11

ALL
MARK
er 1716

L
er 1713

zer NEWHALL
EED
r 1718

ALL
ED
17

HALL
WLE
1721, Woburn, Middlesex co., MA

ALL
D
r 1724

L
RAGE
2/3

ER
ber 1708, Lynn, Essex co., MA

R

Hugh ALLEY
& Rebecca HOOD
m. 9 December 1681, Lynn, Essex co., MA

Solomon ALLEY

Hannah ALLEY

Jacob ALLEY

Thomas NEWHALL
& Rebecca GREENE
m. 9 November 1674, Malden or Charlesto

John NEWHALL 3rd
& Esther BARTRAM
m. 18 June 1677, Lynn, Essex co., MA

Ensign Joseph NEWHALL
m. circa 1678, Lynn, Essex co., MA

Nathaniel NEWHALL
& Elizabeth SYMONDS
m. by 1685, Lynn, Essex co., MA

Elizabeth1 NEWHALL

Elisha NEWHALL

Elizabeth2 NEWHALL

Mary NEWHALL

Samuel NEWHALL
& Abigail LINDSEY
m. 31 December 1695, Lynn, Essex co., MA

Rebeca NEWHALL
& Ebenezer PARKER
m. 22 May 1697

Hanna FARRAR
& Thaddeus BERRY
m. circa 1664, Rumney Marsh, Suffolk, co

Susanna FARRAR

Thomas FARRAR
& Abigail COLLINS
m. 3 March 1680/1, Lynn, Essex co., MA
& Elizabeth HOOD
m. 6 December 1682, Lynn, Essex co., MA

Peleg FARRAR

Mehitabel FARRAR

Elizabeth FARRAR

Sarah FARRAR

Robert POTTER Jr.
m. 9 January 1681/2, Lynn, Essex co., MA

Nathaniel POTTER

John POTTER
& Elizabeth NORWOOD
m. 27 May 1692, Lynn, Essex co., MA

Elizabeth1 POTTER

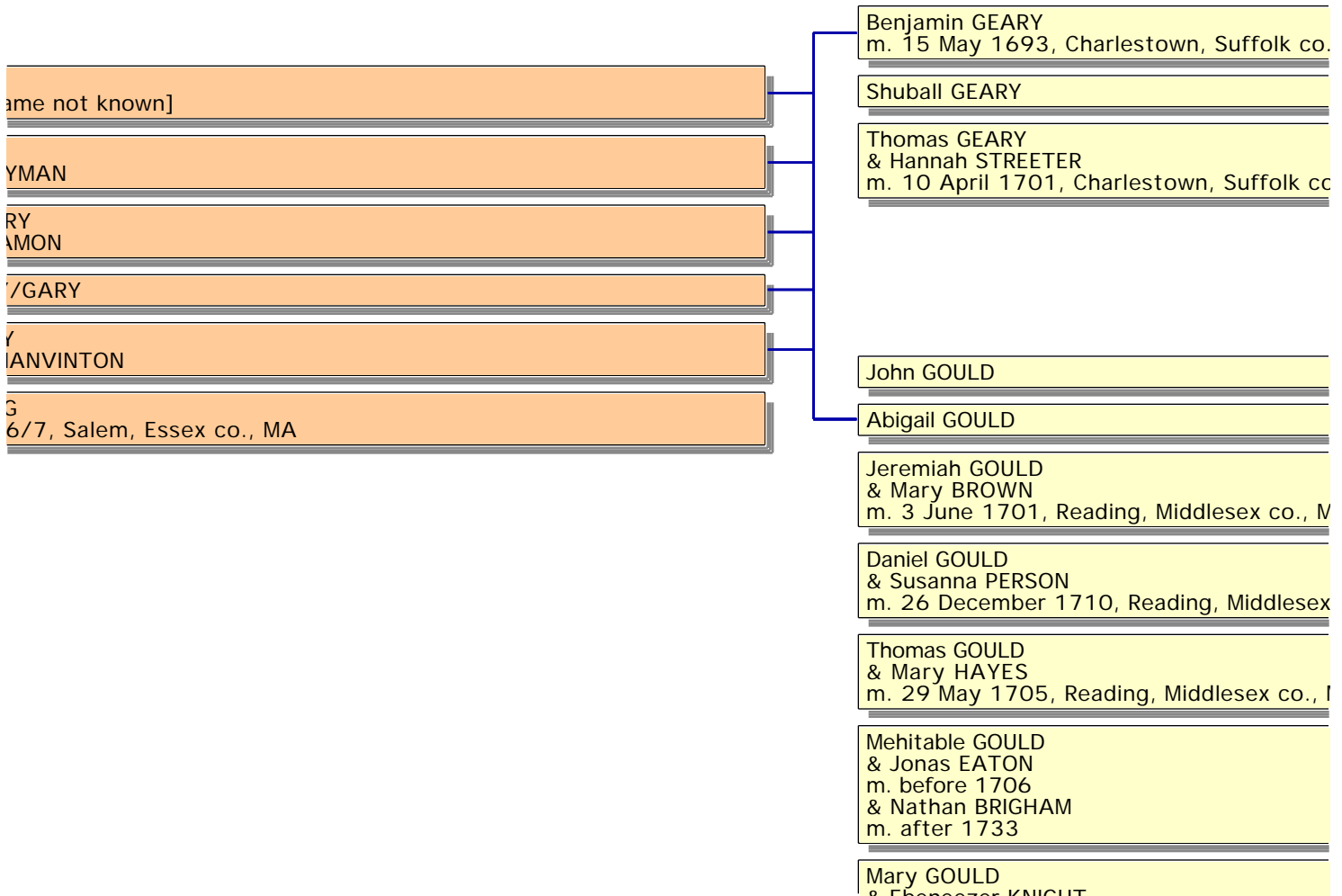
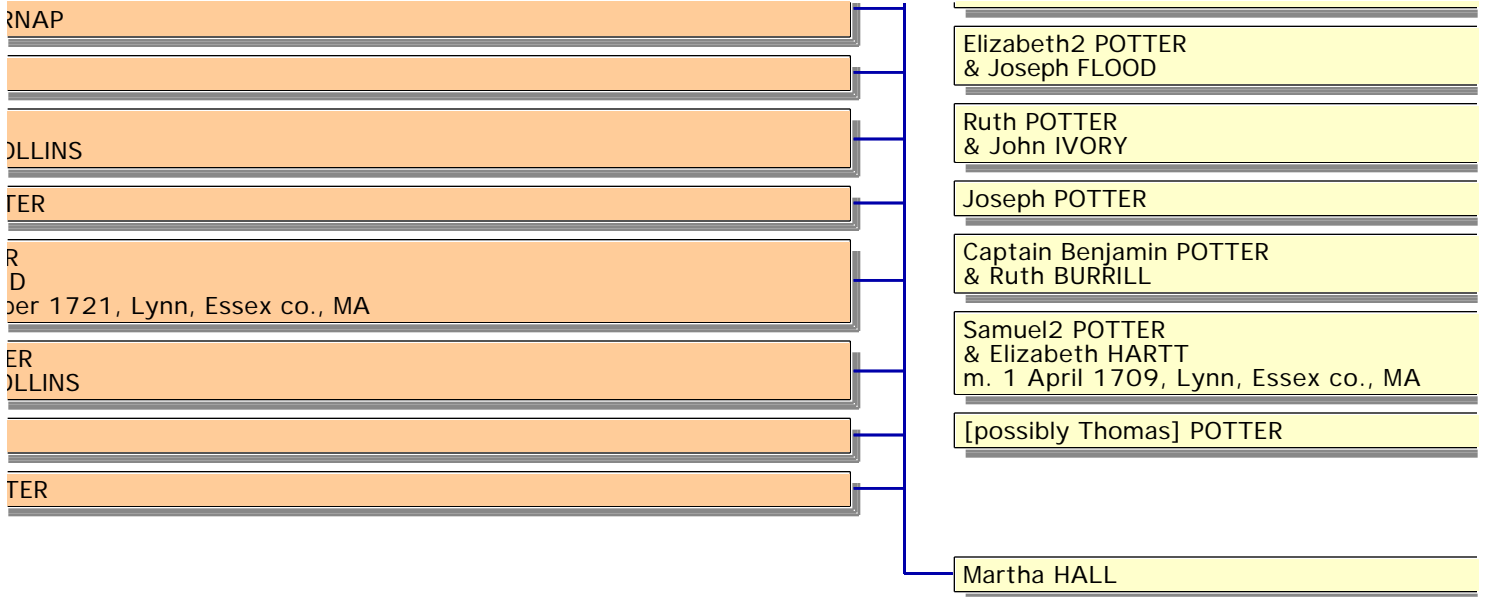

& Ebenezer KNIGHT

James GOOLD

S
R
1722, Lynn, Essex co., MA

S
1722, Lynn, Essex co., MA - by Rev. Nathaniel Henchman [+int.]

OMSON/THOMSON
er 1721, Lynn, Essex co., MA

S
/ES
/ 1722/3, Lynn, Essex co., MA

ES
SKEY
25/27 Jan 1725[-6], Marblehead, Essex co., MA

TES

S

S
N
15, Marblehead, Essex co., MA

Jane COATES
& Joseph ROODS
m. 25 May 1674, Lynn, Essex co., MA

Elizabeth COATES
& Josiah ROODS
m. 23 July 1673, Lynn, Essex co., MA

James COATES

John COATES
m. 3 November 1690, Lynn, Essex co., MA

Thomas COATES
& Martha GAY/GEE
m. 29 December 1685, Lynn or Newbury, MA

Also HENLEY

Samuel HARTT
& Elizabeth INGOLS
m. 4 January 1680, Lynn, Essex co., MA
& Abigail LOMBARD
m. 9 June 1684, Lynn, Essex co., MA

Hannah HARTT

Joseph HARTT
m. 24 June 1685, Lynn, Essex co., MA

Abigail HARTT

John1 HARTT

Rebekah HARTT

Ezekial/Ezekiel HARTT

William1 HARTT

Mary HARTT

[Redacted]

[Redacted]

[Redacted]

[Redacted]

[Redacted]

[Redacted]

[Redacted]

[Redacted]

[Redacted]

SER
 MPSON
 rlestown, Suffolk co., MA
 VENSON
 '8, Charlestown, Suffolk co., MA

SER
 VE
 .ER

ETSER

R

SER

SER
 , Charlestown, Suffolk co., MA

SWEETSER

Ruth CHADWELL

Thomas CHADWELL
 & Hannah SMITH
 & Sarah BROWN

Lois CHADWELL

Margaret CHADWELL

Anna CHADWELL

Sarah CHADWELL

Moses CHADWELL

Elizabeth CHADWELL

Benjamin SWEETSER
 m. circa 1660, Charlestown, Suffolk co., M

Hannah SWEETSER
 & Joseph FITCH

Sarah SWEETSER

Mary SWEETSER
 & Samuel BLANCHARD

Elizabeth SWEETSER
 & Samuel HOWARD
 m. 1661 or 1662, Malden, Middlesex co., I

Abigail WIGGLESWORTH

Michael WIGGLESWORTH
 & Mary RAYNER
 & Martha MUDGE
 m. after 1659, Charlestown, Suffolk co., M
 & Sybil AVERY
 m. after 1694, Charlestown, Suffolk co., M

John SPRAGUE Jr.
 m. circa 1676, Charlestown, Suffolk co., M

Jonathon SPRAGUE

Samuel SPRAGUE

Mary SPRAGUE

Phineas SPRAGUE

Deborah SPRAGUE
 & William MELLENS

E
GUE
E
E
JFTS
AGUE
UE

& Samuel BUCKNAM
Sarah SPRAGUE
& Jonathon FOSDICK
Hannah SPRAGUE
& Samuel STOWER
m. 1706
Lydia SPRAGUE
& John GREENFIELD
Edward SPRAGUE

Samuel STOWERS
Elizabeth STOWER
Mary STOWER
& John BURRILL
Sarah STOWER
& John CARTER
Hannah STOWERS
& Abraham HILL
m. 1666, Charlestown, Suffolk co., MA

Mary SMITH
& Jeremiah SWAIN
m. 5 November 1664, Reading, Middlesex
John SMITH
Sarah SMITH
Isaac SMITH
Benjamin SMITH
Deacon Francis SMITH
m. 1 March 1679/80, Reading, Middlesex
Abraham SMITH
& Elizabeth PIERCE

ber 1709, Charlestown, MA [CVR] by Mr. Justice Emerson
H
TH
CH
4. Reading, Middlesex co., MA

John MAVERICK
& Catharine SKIPPER
m. 9d:2m:1656, Boston, Suffolk co., MA
Abigail MAVERICK
& Matthew CLARK
& Benjamin BALCH

Reading, Middlesex co., MA

TH

AP
 732, Reading, Middlesex co., MA

OWLTON
 ber 1722, Reading, Middlesex co., MA

PERSON
 ber 1724, Reading, Middlesex co., MA

& Benjamin BALCH

Elizabeth MAVERICK
 & John JOHNSON
 m. before 1659, Haverhill, Essex co., MA

Sarah MAVERICK
 & Samuel WALTON

Elias MAVERICK
 & Margaret SHERWOOD
 m. 8 December 1669, Charlestown, Suffolk

Peter MAVERICK
 & Martha BRADFORD

James MAVERICK
 & Esther BRINTNALL

Mary MAVERICK
 & Aaron WAY Jr.

Ruth MAVERICK

Paul MAVERICK
 & Jemima SMITH

Rebecca MAVERICK
 & [not known] THOMAS

urname not known]

RCE

RCE

E

CE

Samuel PIERCE
 & Mary ORTON

Mary PIERCE
 & Captain John LYNDE
 m. 1672/1678, Charlestown, Suffolk co.,

Thomas PIERCE
 & Elizabeth HALL

John1 PIERCE

Joseph PIERCE

Jonathon PIERCE
 m. 4d:10m(December):1683, Charlestown

John2 PIERCE

Elizabeth PIERCE
 & Johna CURTICE

Persis PIERCE
 & John SHEPHERD

Abigail PIERCE

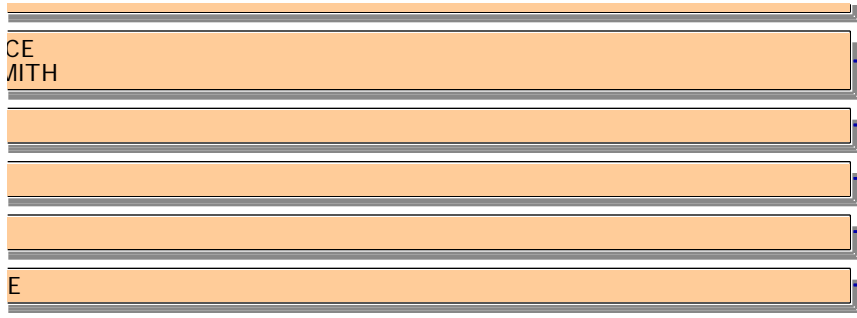

Hannan PIERCE
& Samuel COUNCE

Benjamin PIERCE

Mary LOBDELL

Nicholas LOBDELL
& Elizabeth PERKINS
m. 18 August 1687, Charlestown, Suffolk

John1 HAWKES

John2 HAWKES
m. 3 June 1658, Lynn, Essex co., MA

Susanna HAWKES
& William COGSWELL
m. 1649, Ipswich, Essex co., MA



Rebecca MAVERICK

Mary1 MAVERICK

Abigail MAVERICK
& Major Samuel WARD

Elizabeth1 MAVERICK

Samuel MAVERICK

Samuel MAVERICK

Elizabeth2 MAVERICK
& nathaniel GRAFTON
& Thomas SKINNER

Remember MAVERICK
& Edward WOODMAN Sr.

SWELL

SWELL
IAWKES
01

WELL
ONS
er 1722

LL

L, 4th
/N

LL
ONS
eptember 1716

Elizabeth COGSWELL
& Abraham WELLMAN

John COGSWELL, 3rd
m. 22 July 1674, Ipswich, Essex co., MA

Samuel COGSWELL
& Susanna HAVEN
m. 27 October 1668

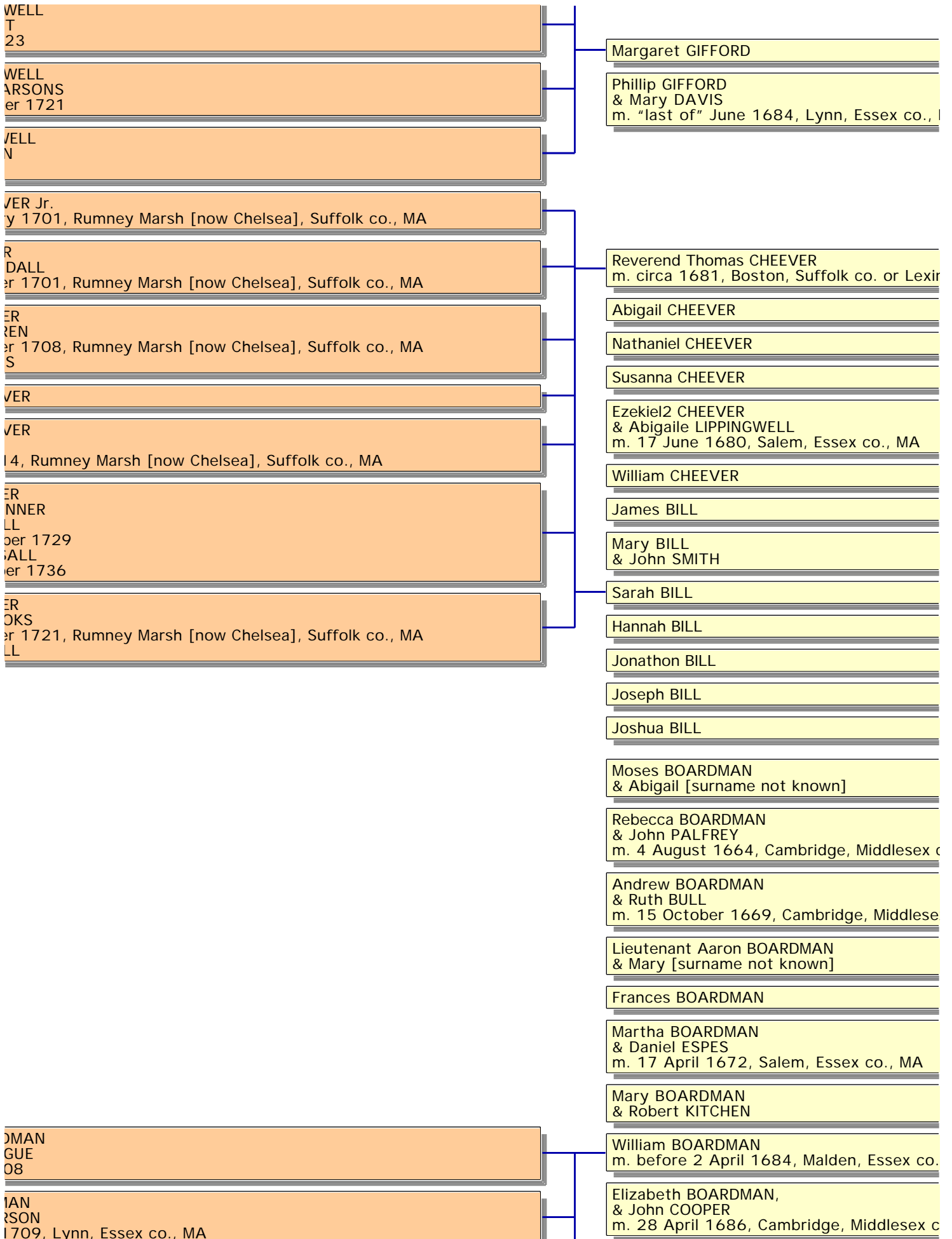

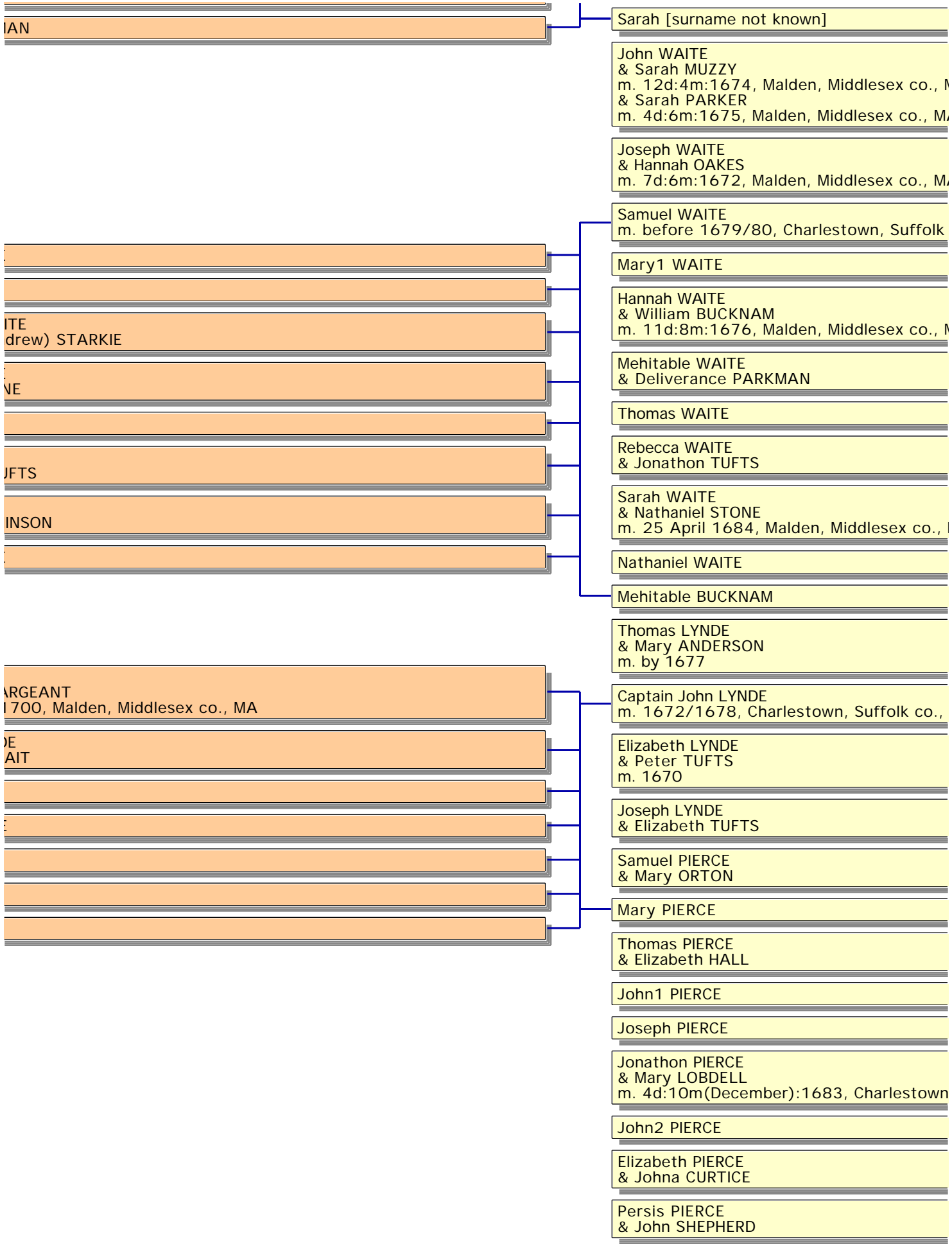

Abigail PIERCE

Hannah PIERCE
& Samuel COUNCE

Benjamin PIERCE

Mehitabell GILES
& John COLLENS
m. 9d:1m:1658/9, Salem, Essex co., MA

Remember GILES
& Henry MOSES
m. 1d:2m(April):1659, Salem, Essex co., MA

Eleazer GILES
& Sarah MORE
m. 25 January 1664/5, Salem, Essex co., MA
& Elizabeth BISHOP
m. 25 September 1677, Salem, Essex co., MA

702, Beverly, Essex co., MA by the Reverend Thomas Blover/Blower

John GILES
m. 5 May 1679, Beverly, Essex co., MA by

Elizabeth GALLEY

John GROVER

Mary GROVER
& Anthony WOOD
m. 11 June 1666, Ipswich, Essex co., MA

Lydia GROVER

Nathaniel GROVER

Deborah GROVER

Nehemiah GROVER
m. 2d:10m(December):1674 (1676?), Beverly

Elizabeth GROVER

Naomie GROVER

[Redacted]

[Redacted]

Deacon William HASKELL
& Mary BROWNE
m. 3d:3m:1667, Gloucester, Essex co., MA

[Redacted]

[Redacted]

Joseph HASKELL
& Mary GRAVES

[Redacted]

[Redacted]

Benjamin HASKELL
& Mary RIGGS
& Emma BOND

[Redacted]

John HASKELL
& Mary BAKER

Ruth HASKELL

Mark HASKELL
& Elizabeth GIDINS/GIDDINGS

Sarah HASKELL
& edward HARADEN

Elinor HASKELL
& Jacob GRIGGS

Mary HASKELL
& Edward DODGE

Jr.
1710, Lynn, Essex co., MA

- Susannah HAWKES
- Adam HAWKES
m. circa 1689, Lynn, Essex co., MA
- Anna HAWKES
- John HAWKES
- Rebecca HAWKES
- Thomas HAWKES
- Mercy HAWKES
& Nathaniel GOODHUE
- Ebenezer HAWKES
- Elizabeth PRATT?! [surname not known]

WHITFORD
ORD
ORD

- John WHITFORD
m. May 1680, Salem, Essex co., MA
- Samuell WHITFORD
- Elizabeth SWASEY
- Abigail SWASEY
- John SWASEY
- Joseph SWASEY
& Elizabeth LAMBERT
- Mary SWASEY
- Samuell SWASEY
- Steeven SWASEY

_ 4th ["Quartus"]
1691, Lynn, Essex co., MA
HALL
ne not known]
HALL
TT/TREVETT
88
HALL
L

- John NEWHALL Jr.
m. 31d:10m (December):1656/7, Lynn, Es
- Mary NEWHALL
& Richard HOOD Sr.
m. circa 1652, Lynn, Essex co., MA

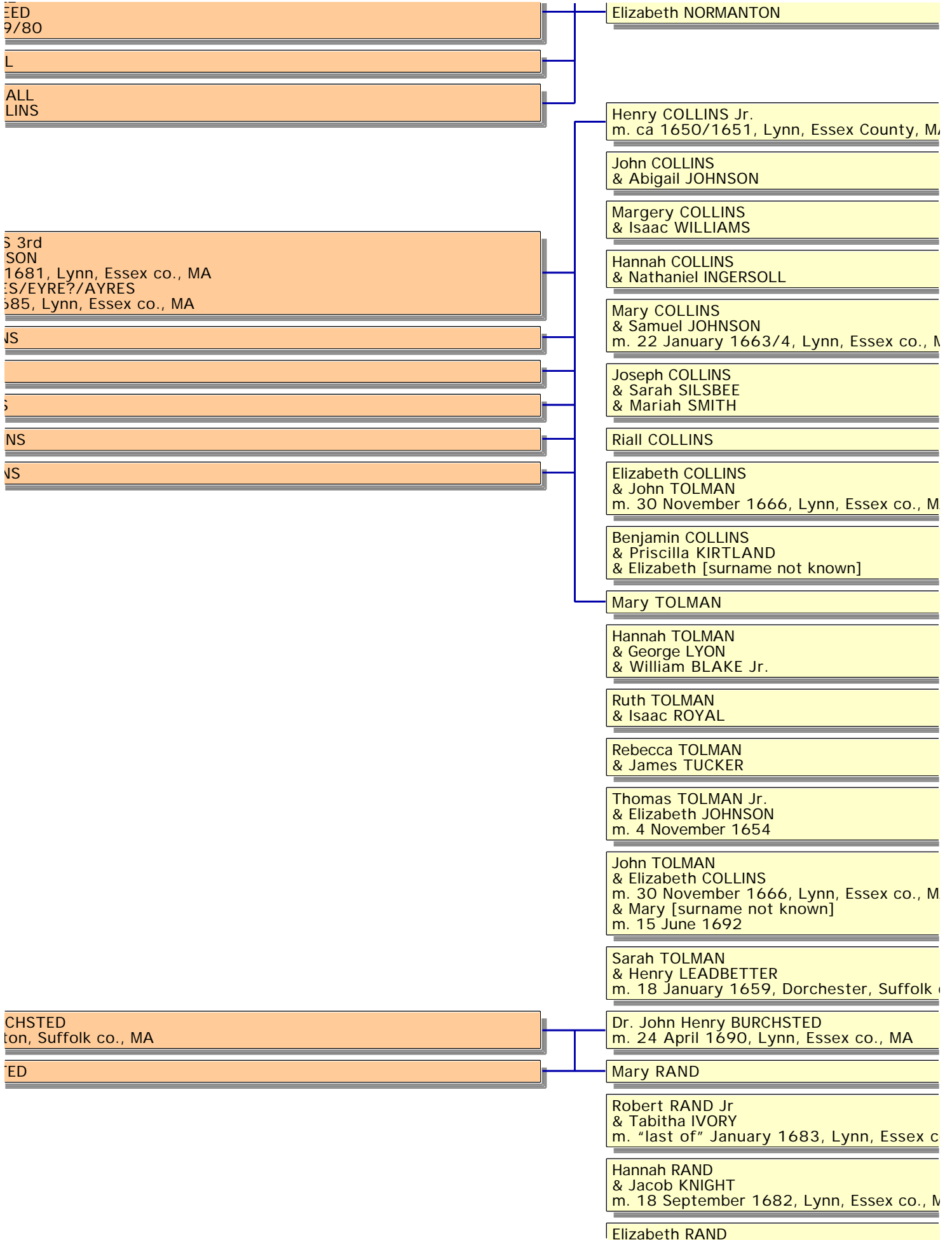

& Joseph HALL
m. 3 March 1673/4, Lynn, Essex co., MA

Sarah RAND
& Ephriam HALL
m. 1 July 1674, Lynn, Essex co., MA

Zachariah RAND
& Anna IVORY
m. 2 April 1684, Lynn, Essex co., MA

[not known] BREAM

Elnathan DUNKLEE
m. 14d:10m:1656, Dedham, Norfolk co., M

Silence BOWERS

KL
1693, Billerica, Middlesex co., MA

Captain William FRENCH Esq.
m. 6 May 1669, Billerica, Middlesex co., M

John FRENCH
& [not known] [surname not known]

Mary LOTHROP

SBY
1, Billerica, Middlesex co., MA

Robert WILSON
m. before 1666, Cambridge, Middlesex co.

Andrew STEVENSON
& Abigail SWEETSER
m. 9d:1m:1678, Charlestown, Suffolk co.,

Sarah STEVENSON
& John LOWDEN
m. 29 May 1662, Cambridge, Middlesex co

Rebeccah STEVENSON
& James PATTESON
m. 29 May 1662, Cambridge, Middlesex co

Deborah STEVENSON

Hannah STEVENSON
& William BURGESS
m. 20 May 1684, Cambridge, Middlesex co

John2 STEVENSON

Lidia STEVENSON

Mary STEVENSON
& Thomas RICHARDSON
m. 5 January 1669, Cambridge, Middlesex

John1 STEVENSON

Thomas WILLIAMS
m. 11 August 1666, Groton, Middlesex co.

Justinian HOLDEN
& Mariah [surname not known]

John HOLDEN
& Hannah LAWRENCE

Stephen HOLDEN

Martha HOLDEN

AMS

S
DODING

IS
BEARD

AMS

AMS

MARY HOLDEN
& Thomas BOYDEN

Mary HOLDEN

Sarah HOLDEN
& Gershom SWAN

Samuel HOLDEN
& Anna [surname not known]

Elizabeth HOLDEN

Thomas HOLDEN

[Redacted]

UTLER

RSH

SH

SH

SH

RSH Sr.
before 1699/1700, Salem, Essex co., MA

H

H

SH

Zachary MARSH
m. 15d:6m(August):1664, Salem, Essex co.

John MARSH

Ruth MARSH

John SILSBEE

Nathaniel SILSBEE

Henry SILSBEE

Ephriam SILSBEE

Sarah SILSBEE
& Joseph COLLINS

Hannah SILSBEE
& Thomas LAIGHTON Jr.
m. 2 December 1680, Lynn, Essex co., MA

Jonathon SILSBEE
& Bethia MARSH
m. 1 January 1673, Lynn, Essex co., MA

Samuel2 SILSBEE
& Mary BISCOW
m. 4 July 1676, Lynn, Essex co., MA

Mary SILSBEE

Samuel1 SILSBEE

[Redacted]

[Redacted]
[Redacted]
before 1692, Lynn, Essex co., MA

TH

[Redacted]
before 1695, Salem, Essex co., MA

[Redacted]

TH

[Redacted]

[Redacted]

H

H

TH

George BOOTH
m. before 1671, Lynn/Salem, Essex co., MA

Alice TEMPLE

NCH
36, Salem, Essex co., MA
[Name not known]

Thomas MOWER
& Mary LEWIS
m. 13 November 1711, Lynn, Essex co., M

Richard1 MOWER

John1 MOWER

Captain Richard2 MOWER
m. 29 March 1705, Lynn, Essex co., MA

Susannah MOWER
& Jonathon JOHNSON
m. 16 January 1728/9, Lynn, Essex co., M

John2 MOWER

Mary MOWER
& William HILL
m. 1728

ER
ERING
1727/8, Lynn, Essex co., MA

Sr.
1732, Lynn, Essex co., MA

LL
r 1743, Lynn, Essex co., MA

rd MOWER Jr.
[Name not known]

Robert SEAVER

Joseph SEAVER

Hannah SEAVER

Thankfull SEAVER

Shuball SEAVER

John1 BURRILL

Sarah BURRILL

Captain John2 BURRILL Esq.
& Mary STOWER
m. 28 July 1680, Lynn, Essex co., MA

Thomas BURRILL

Anna BURRILL

Theophilous BURRILL Esq.
& Lydia GATHERCOLE
m. 5 July 1694, Boston, Suffolk co., MA

Lois BURRILL
& Samuel SPRAGUE
m. 5 June 1695, Boston, Suffolk co., MA

Samuel BURRILL

Mary BURRILL

Honorable Ebenezer BURRILL Esq.
m. 13 October 1702, Lynn, Essex co., MA

Ruth BURRILL
& Captain Benjamin POTTER

RRILL, Jr.

.L

RRILL

L

.L

R

r 1743, Lynn, Essex co., MA

Sarah1 FARRINGTON

Sarah2 FARRINGTON

Martha FARRINGTON

SammueII FARRINGTON

Joseph FARRINGTON

Timothy BREED
& Sarah BRAN
m. after 27 November 1688
& Sarah NEWHALL
m. 3 Mar 1679/80

Ensign Joseph BREED
& Sarah² FARRINGTON
m. 27 September 1683, Lynn, Essex co., M

Allen BREED
& Elizabeth BALLARD
m. 22d:3m:1684, Lynn, Essex co., MA

Captain John BREED
& Mercy PALMER

Mary BREED
& Thomas LEWIS

Elizabeth BREED
& Thomas BURRAGE

Samuel BREED
m. 5 February 1691/2, Lynn, Essex co., M

D

D

r 1728, Lynn, Essex co., MA

HALL
r 1724

ED

n

Mary HOOD

Richard HOOD, Jr.
& Hannah BERRY
m. circa 1688

Sarah HOOD
& William BASSETT Jr.
m. 25 October 1675, Lynn, Essex co., MA

Elizabeth HOOD

ED
ED
ED

- EMERSON HOOD
- Ruth HOOD
- Rebecca HOOD
- John HOOD
- Hannah HOOD
- Samuel HOOD
- Nathaniel HOOD
- Anna HOOD
- Joseph HOOD
- Benjamin HOOD

- Sarah BASSETT
- William BASSETT III
& Rebecca BERRY
m. 14d:11m:(January):1703/4, Lynn, Ess
- Mary BASSETT
- John BASSETT
m. 9d:12m:(February):1704/5, Lynn, Esse
- Hannah BASSETT
- Ruth BASSETT
- Joseph BASSETT
- Deliverance BASSETT
& Samel BREED, Jr.
- Abigail BASSETT

TT
BETT
T
T
T
T

John BERRY
& Rachel LEACH

Elizabeth BERRY
& Joseph TOWNSEND
m. 22 May 1690, Boston, Suffolk co., MA

Samuel BERRY

Hannah BERRY
& Richard HOOD, Jr.
m. circa 1688
& Edmond NEEDHAM
m. after 7 September 1696

Thomas BERRY
& Elizabeth DIVAN
m. before 1695, Lynn, Essex co., MA

Daniel BERRY
& Mary MAYER
m. 8 July 1697

Sarah BERRY
& Thomas STOCKER
m. 29 November 1700, Lynn, Essex co., M

Ephriam BERRY

Athelrid/Ethelred BERRY
& William MERRIAM
m. 20 December 1695, Lynn, Essex co., M

Rebecca BERRY
& William BASSETT III
m. 14d:11m:(January):1703/4, Lynn, Ess

Abigail BERRY

Jerusha BERRY
& Ebenezer MERRIAN/MERRIAM
m. 13 February 1709/10, Lynn, Essex co.

Mehitable BERRY

Ruth WOODMAN

Mary WOODMAN

Elizabeth WOODMAN

Edward1 WOODMAN

Rebecca1 WOODMAN

Sara WOODMAN

Rebecca2 WOODMAN

Judith WOODMAN

Edward2 WOODMAN
m. 29 June 1702, Newbury, Essex co., MA

Abelard WOODMAN

DMAN
N
MAN

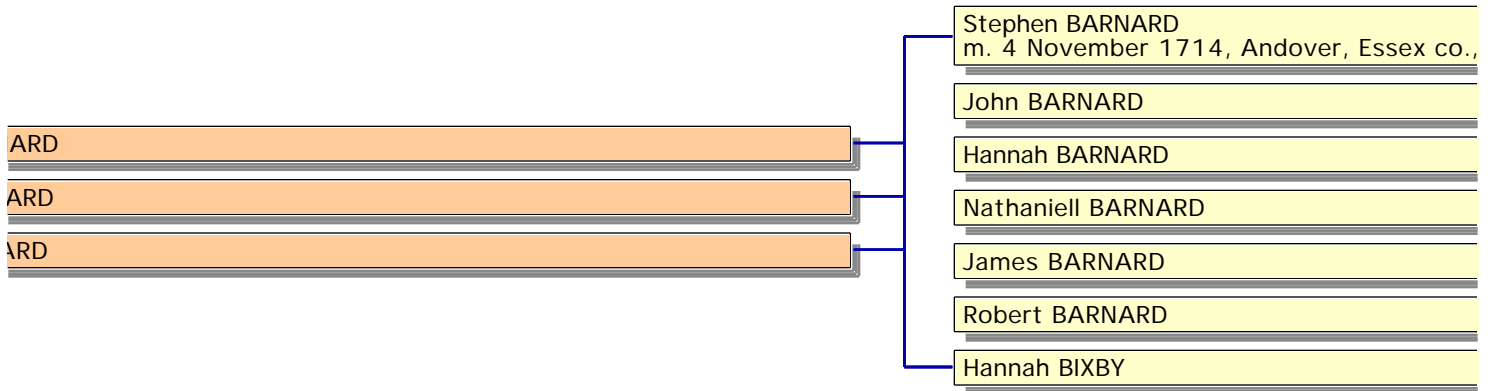
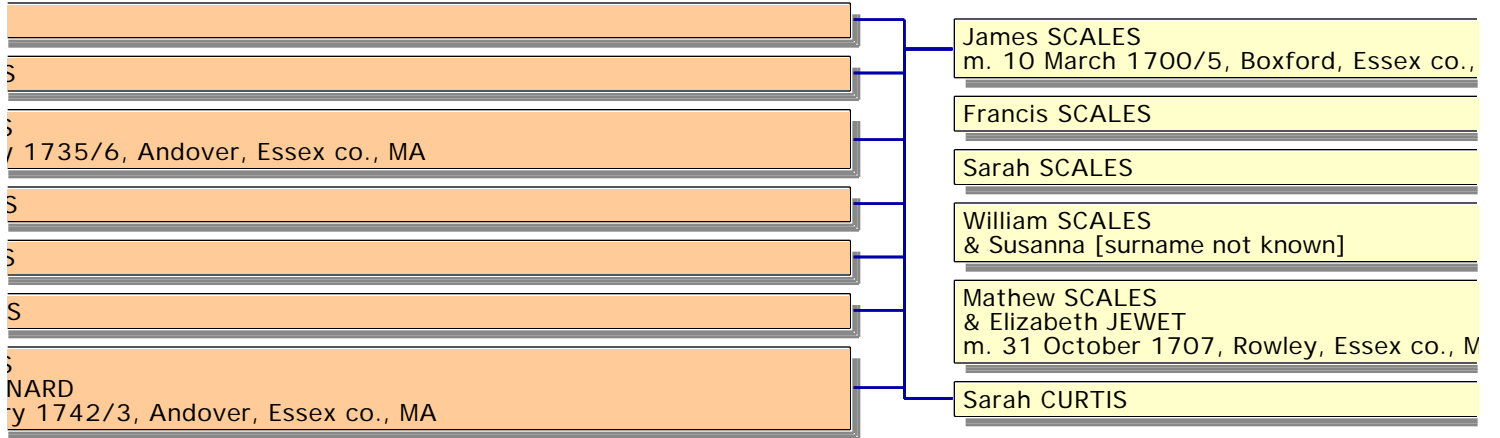
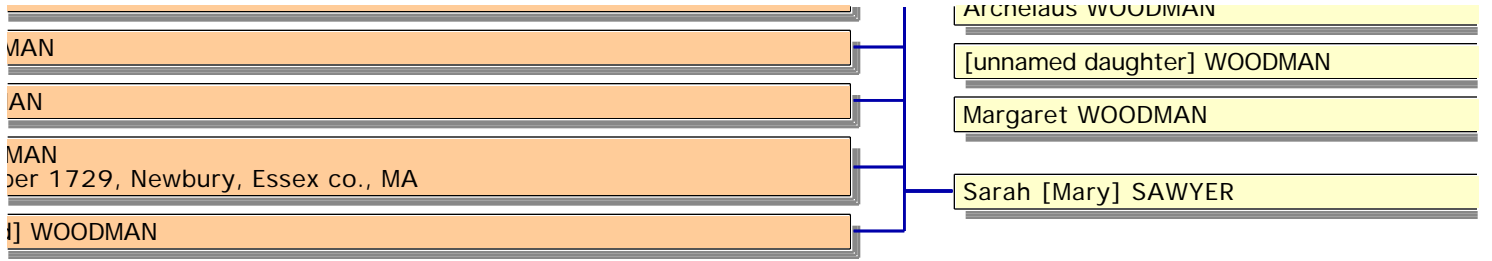

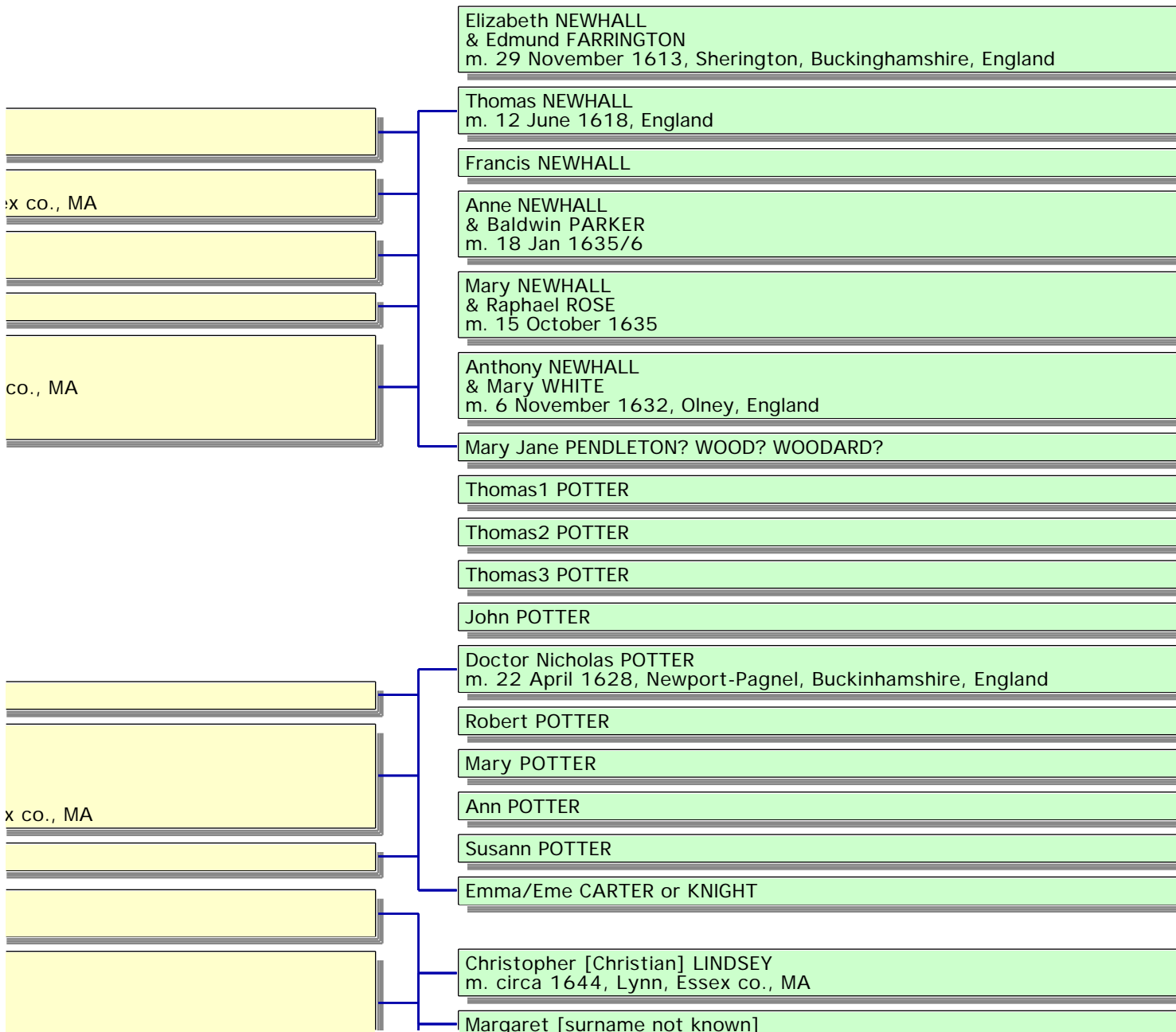

co., MA

MA

Hugh ALLEY
m. 1641/1642, Lynn, Essex co., MA

Mary GRAVES

Thomas HANSON
m. circa 1641, Dover, Rockingham co., NH

Edward HANSON

Elizabeth HANSON

Mary PAUL

John KITCHEN
m. after 28 October 1643, Salem, Essex co., MA

Elizabeth GRAFTON

Allen BREED
m. 14 November 1622, Pullohill, Bedfordshire, England

Mary BREED

Clemente1 BREED

Clemente2 BREED

Margaret BREED

John BREED

Ann BREED

Elizabeth WHEELER

Captain Thomas WHEELER

Timothy WHEELER

Joseph WHEELER

Ephraim WHEELER
Susannah WHEELER
& Obadiah WHEELER

Daniel SARGENT
Sara SARGENT
Anna SARGENT
Samuel SARGENT
Mary SARGENT
Joseph SARGENT
& Dorothy [surname not known]
Dorothy SARGENT
& Thomas BALL
m. 4 November 1634, All Saints, Northampton, Northamptonshire, England

Reverend William SARGENT
m. circa 1634, All Saints, Northampton, Northamptonshire, England

[unnamed son] SARGENT

John SARGENT
& Anne ORPYN
m. 4 November 1634, All Saints, Northampton, Northamptonshire, England

Elizabeth SARGENT
& Robert BANKS
m. 9 October 1626, All Saints, Northampton, Northamptonshire, England
& Henry SPRIGG
& George NORWOOD

Mary/Marie [surname not known]

Edmund FARRINGTON
m. 29 November 1613, Sherington, Buckinghamshire, England

Elizabeth NEWHALL

Thomas NEWHALL
& Mary Jane PENDLETON? WOOD? WOODARD?
m. 12 June 1618, England

Francis NEWHALL

Anne NEWHALL
& Baldwin PARKER
m. 18 Jan 1635/6

Mary NEWHALL
& Raphael ROSE
m. 15 October 1635

...

[Yellow box]

[Yellow box]

[Yellow box]

[Yellow box]

[Yellow box]

[Yellow box]

[Yellow box]

[Yellow box]

[Yellow box]

[Yellow box]

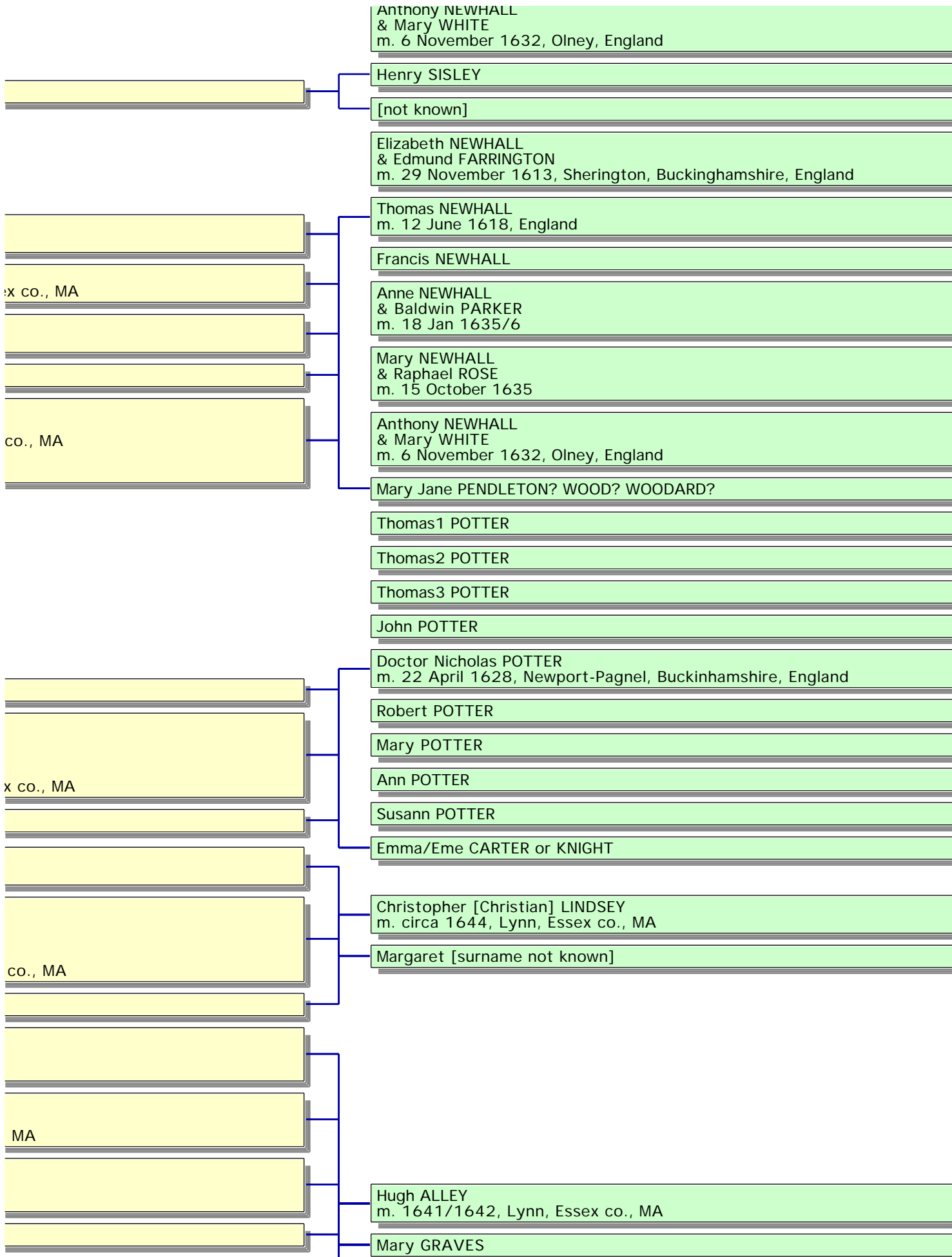

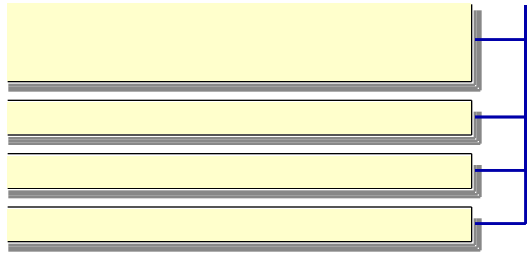

wn

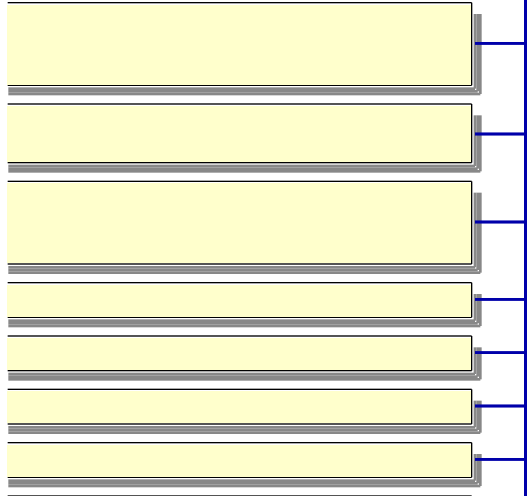

A

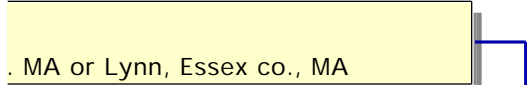
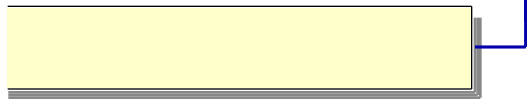

. MA or Lynn, Essex co., MA

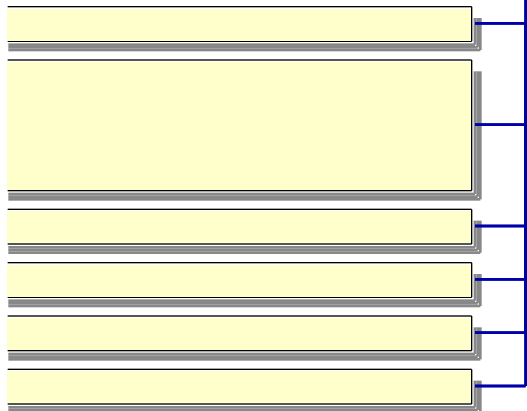

A

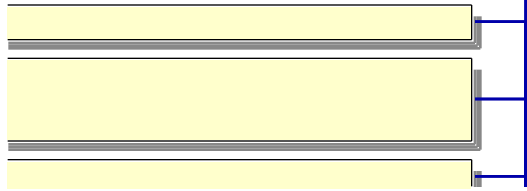

Susanna NEWHALL
& Richard HAVEN

Thomas NEWHALL
m. 29d:10m (December):1652, Lynn, Essex co., MA

Mary NEWHALL
& Thomas BROWN

Francis NEWHALL

John NEWHALL
& Elizabeth LAIGHTON
m. 3d:12m (February):1657, Lynn, Essex co., MA
& Sarah FLANDERS
m. 17 July 1679, Lynn, Essex co., MA

Elizabeth POTTER

Captain Robert POTTER
& [not known] [surname not known]
m. before 1657, Lynn, Essex co., MA
& Ruth DRIVER
m. 25d:11m(November):1659, Lynn, Essex co., MA

Samuel POTTER

Thomas FARRAR
m. circa 1645, Roxbury, Suffolk co., MA or Lynn, Essex co., MA

Elizabeth [surname not known]

Elizabeth POTTER
& Thomas NEWHALL
m. 29d:10m (December):1652, Lynn, Essex co., MA

Captain Robert POTTER

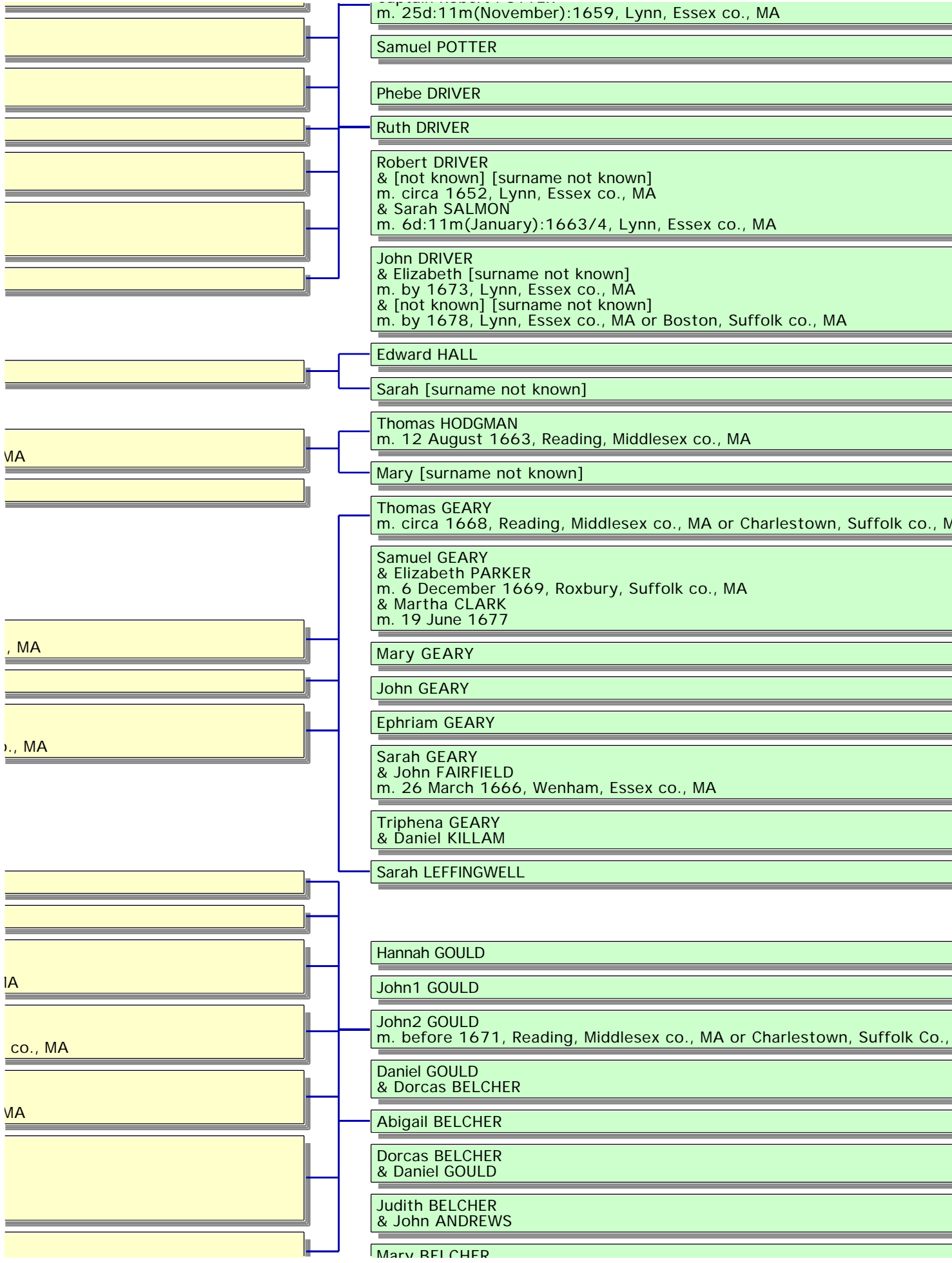

[Redacted]

Mary BELCHER
& Thomas ANDREWS
m. 9 February 1681, Ipswich, Essex co., MA

David BELCHER

Richard BELCHER
& Mary SIMSON
m. 20 May 1689, Ipswich, Essex co., MA
& Ruth KNIGHT
m. 11 October 1705, Woburn, Middlesex co., MA

Ann BELCHER
& Moses BURNHAM

[Redacted]

[Redacted]

[Redacted]

[Redacted]

Essex co., MA

[Redacted]

Thomas COATES
m. by 1646, Lynn, Essex co., MA

Elizabeth2 FLOOD/FLOYD

Obediah FLOOD/FLOYD

Joseph1 FLOOD/FLOYD

Abel FLOOD/FLOYD

Elizabeth1 FLOOD/FLOYD

Persis FLOOD/FLOYD

John FLOOD/FLOYD

Phebe FLOOD/FLOYD

Caleb FLOOD/FLOYD

Joseph2 FLOOD/FLOYD

Eleazer FLOOD/FLOYD

[Redacted]

[Redacted]

[Redacted]

[Redacted]

[Redacted]

[Redacted]

[Redacted]

[Redacted]

[Redacted]

[Redacted]

Samuell HARTT
m. by 1653/1656, Lynn, Essex co., MA

Mary NEEDHAM

John NEEDHAM

Elizabeth1 NEEDHAM

Elizabeth2 NEEDHAM
& Joseph MANSFIELD

Abigail NEEDHAM

Daniel [Nathaniel] NEEDHAM

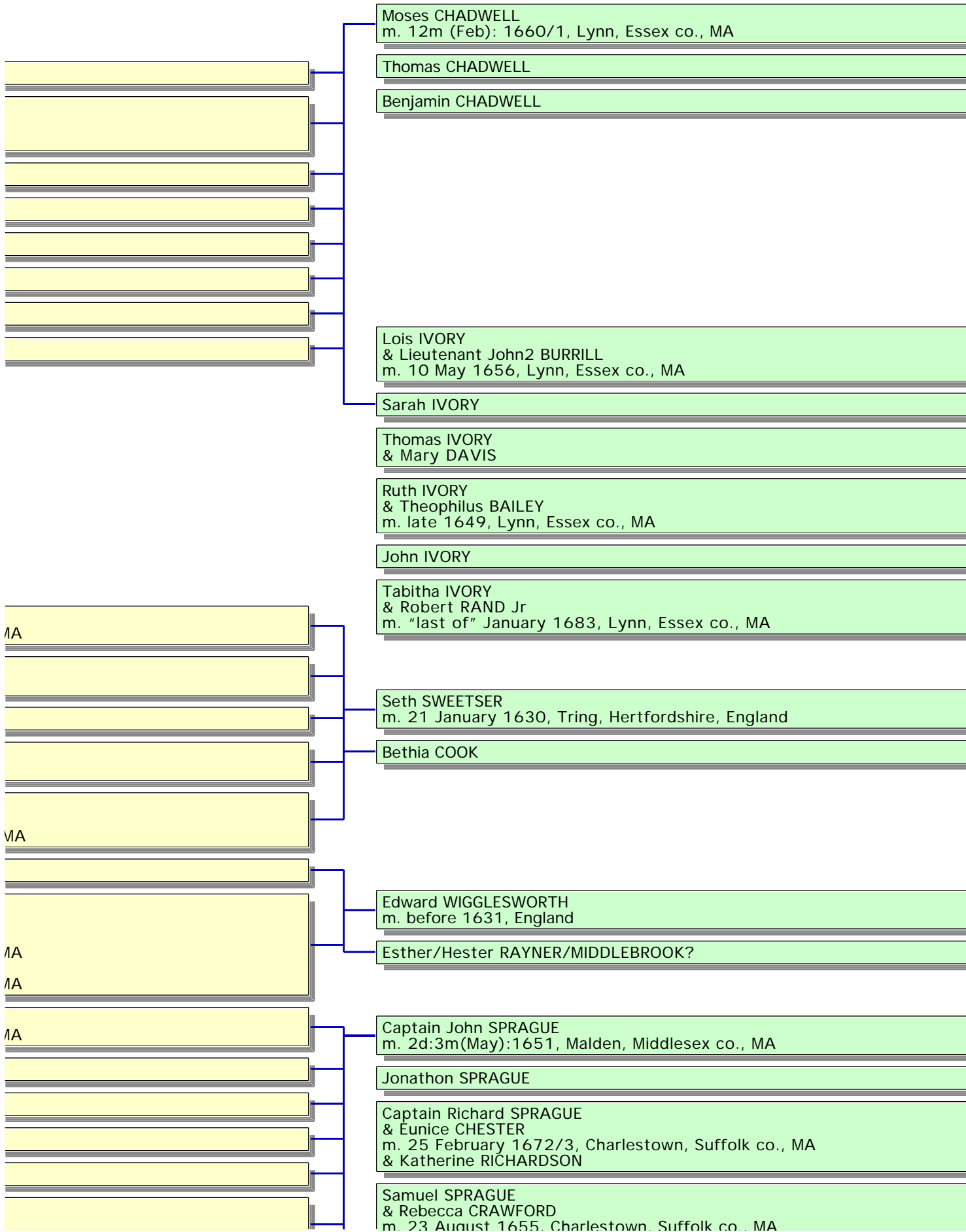

m. 20 August 1669, Charlestown, Suffolk co., MA

Mary SPRAGUE
& Daniel EDMANDS/EDMUNDS

Phineas SPRAGUE
& Mary CARRINGTON
m. 11 December 1661
& Sarah HERSEY
m. 5 January 1669/70

Lydia GOFFE

Samuel GOFFE
& Hannah BARNARD
m. 25 June 1656, Cambridge, Middlesex co., MA

Nathanael GOFFE

Elizabeth STOWERS
& George FARR
m. before 1630, England

Richard STOWERS
m. before 15 October 1647, Charlestown, Suffolk co., MA

Joanna STOWERS
& John BURRAGE

Sarah STOWERS
& Samuel HAYWARD

Joseph STOWERS
& Mary BLAISDELL

Abigail STOWERS
& John KNIGHT Jr.

John STOWERS

Hannah FROST

Lieutenant & Captain John SMITH
m. 1 August 1647, Reading, Middlesex co., MA

Benjamin SMITH
& Jehodan PALFREY
m. 27 March 1661, Reading, Middlesex co., MA

Hannah SMITH
& George LILLEY
m. 15 November 1659, Reading, Middlesex co., MA

Mary SMITH
& Jeremiah SWAIN
m. 1664

Andrew SMITH

Catherine MORRILL

Samuel MAVERICK
& Amias COLE

Elias MAVERICK
m. before 1635, Dorchester or Charlestown, Suffolk co., MA

Marv1 MAVERICK

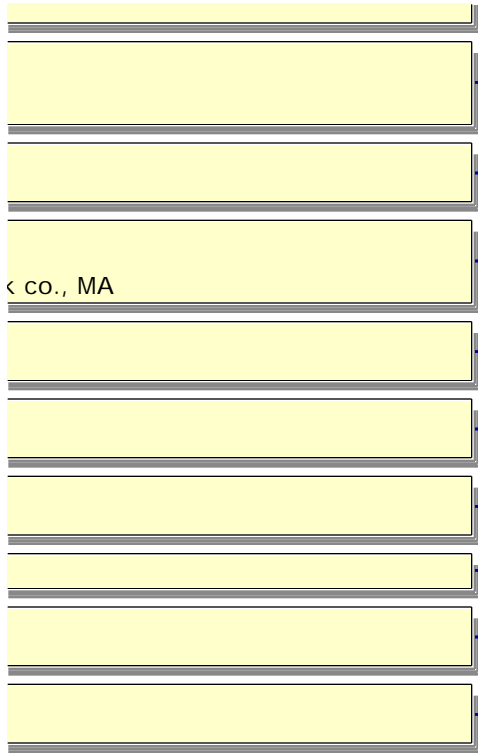

Mary MAVERICK

Aaron MAVERICK

Mary2 MAVERICK
& Reverend James PARKER
m. circa 1635, Dorchester, Suffolk co., MA

Moses MAVERICK
& Remember ALLERTON
m. before 6 May 1635, Plymouth, Salem or Marblehead, MA
& Eunice COLE
m. 22d:8m(October):1656, Boston, Suffolk co., MA

Abigail MAVERICK
& John MANNING
m. before 1643, Dorchester, Suffolk co., MA

Antipas MAVERICK
& [not known] [surname not known]
m. circa 1648, Dorchester, Suffolk co., MA

John MAVERICK
& Jane ANDREWES
m. 15 April 1649, All Hallows London Wall, London, England

Anna HARRIS

John HARRIS
& Bridget [surname not known]
m. before 1645
& Elizabeth ROWLANDSON
m. 24 October 1677, Rowley, Essex co., MA
& Alice [surname not known]

Thomas HARRIS
& Martha LAKE
m. 15 November 1647, Ipswich, Essex co., MA

William HARRIS
& Edith [surname not known]
m. before 1645
& Lydia WRIGHT

Anthony HARRIS
& Elizabeth [surname not known]
m. before 1651

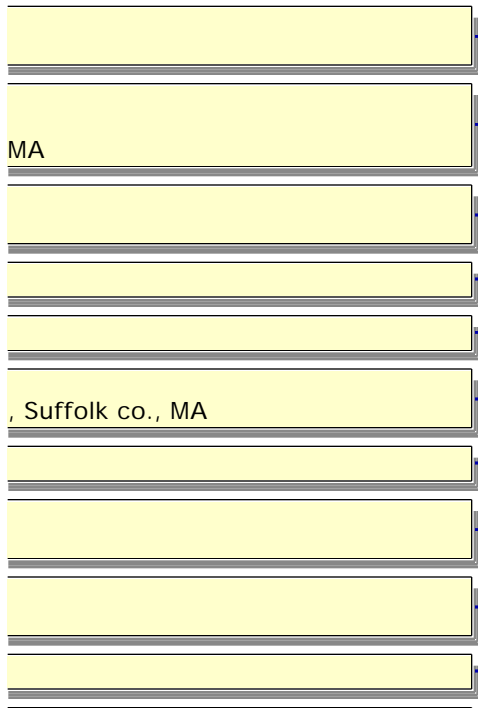

Daniel HARRIS
& Mary WELD
m. before 1651

Samuel PIERCE
m. before 1655, Malden, Middlesex co., MA or Charlestown, Suffolk co., MA

John PIERCE

Sergeant Thomas PIERCE

Mary PIERCE
& Peter TUFTS

Persis PIERCE
& William BRIDGE

Elizabeth PIERCE
& R NICHOLS

Mary [surname not known]

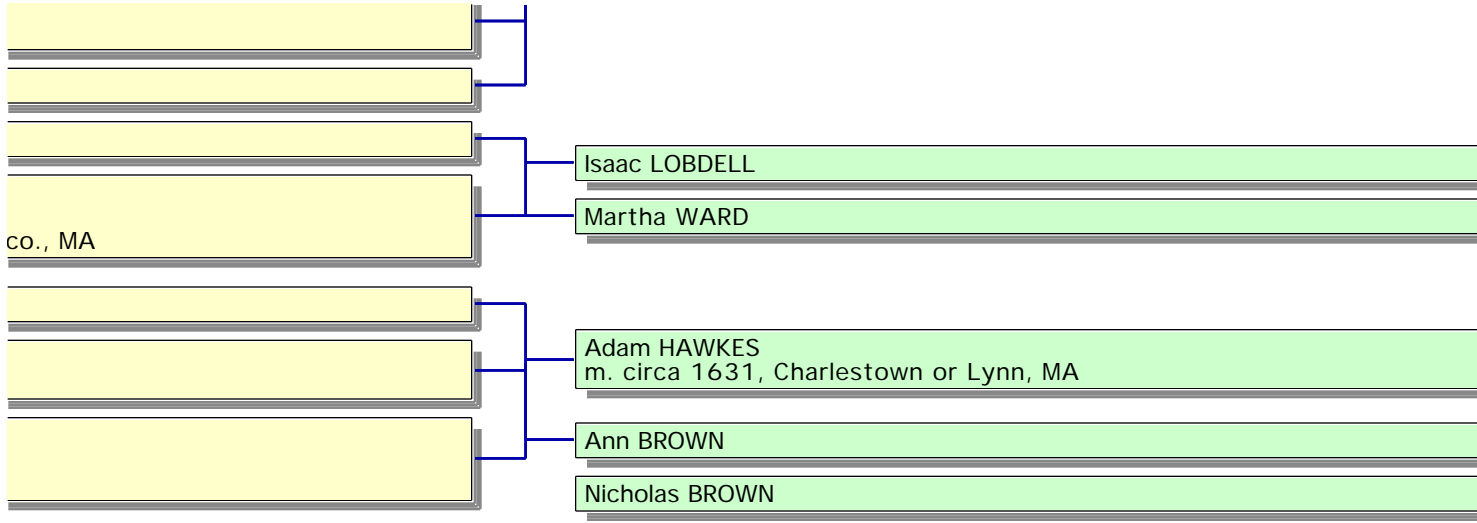

- Samuel MAVERICK & Amias COLE
- Elias MAVERICK & Anna HARRIS
m. before 1635, Dorchester or Charlestown, Suffolk co., MA
- Mary1 MAVERICK
- Aaron MAVERICK
- Mary2 MAVERICK & Reverend James PARKER
m. circa 1635, Dorchester, Suffolk co., MA
- Moses MAVERICK
m. before 6 May 1635, Plymouth, Salem or Marblehead, MA
- Abigail MAVERICK & John MANNING
m. before 1643, Dorchester, Suffolk co., MA
- Antipas MAVERICK & [not known] [surname not known]
m. circa 1648, Dorchester, Suffolk co., MA
- John MAVERICK & Jane ANDREWES
m. 15 April 1649, All Hallows London Wall, London, England

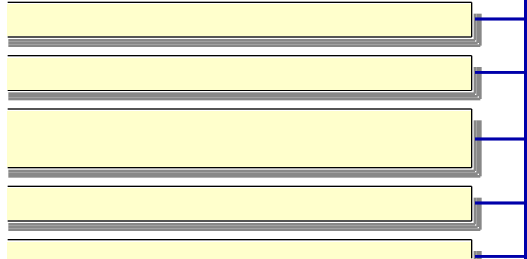

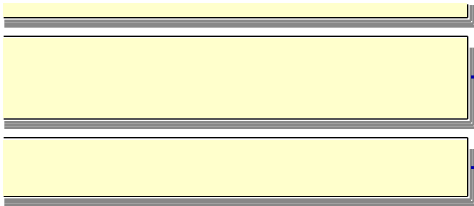

Bartholomew ALLERTON
& Margaret [surname not known]
& Sarah FAIRFAX

Remember ALLERTON

Mary ALLERTON
& Thomas CUSHMAN
m. circa 1636, Plymouth, Plymouth co., MA

[unknown child] ALLERTON

[stillborn son] ALLERTON

Elizabeth COGSWELL
& Nathaniel MASTERSON
m. 31 July 1657, Ipswich, Essex co., MA

Mary COGSWELL
& Godfrey ARMITAGE
m. 1649, Boston, Suffolk co., MA

William COGSWELL
& Susanna HAWKES
m. 1649, Ipswich, Essex co., MA

John COGSWELL, Jr.
m. circa 1648, Ipswich, Essex co., MA

Phyllis COGSWELL

Hannah COGSWELL
& Deacon Cornelius WALDO
m. bef 2 Jan 1651/2, Ipswich, Essex co., MA

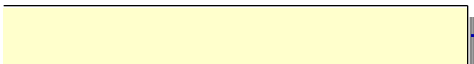

Esther COGSWELL



Edward COGSWELL

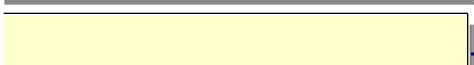

Alice COGSWELL

Ruth COGSWELL

Abigail COGSWELL
& Thomas CLARK
m. bef 1664/1666, Boston, Suffolk co., MA

Sarah COGSWELL
& Simon TUTTLE
m. before 1664, Ipswich, Essex co., MA

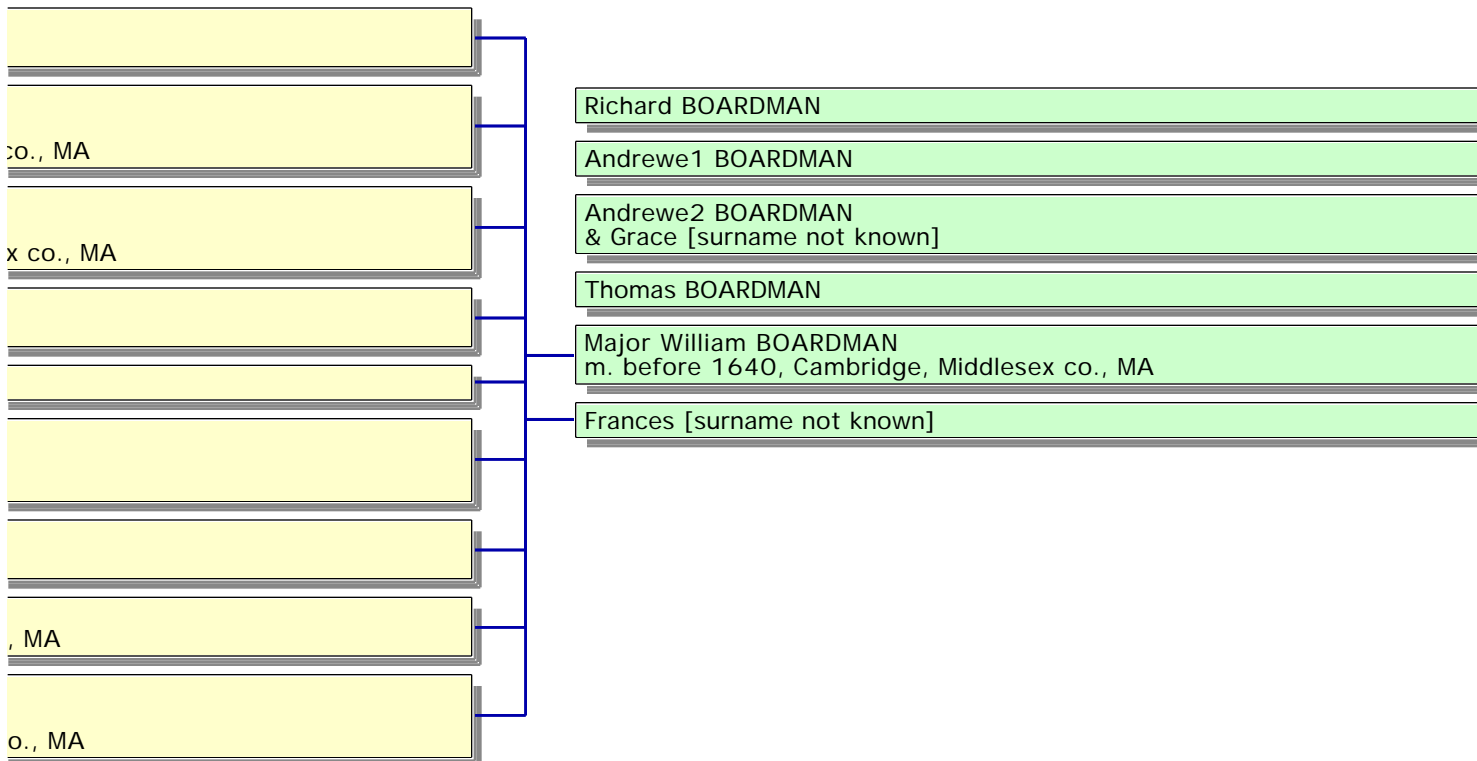
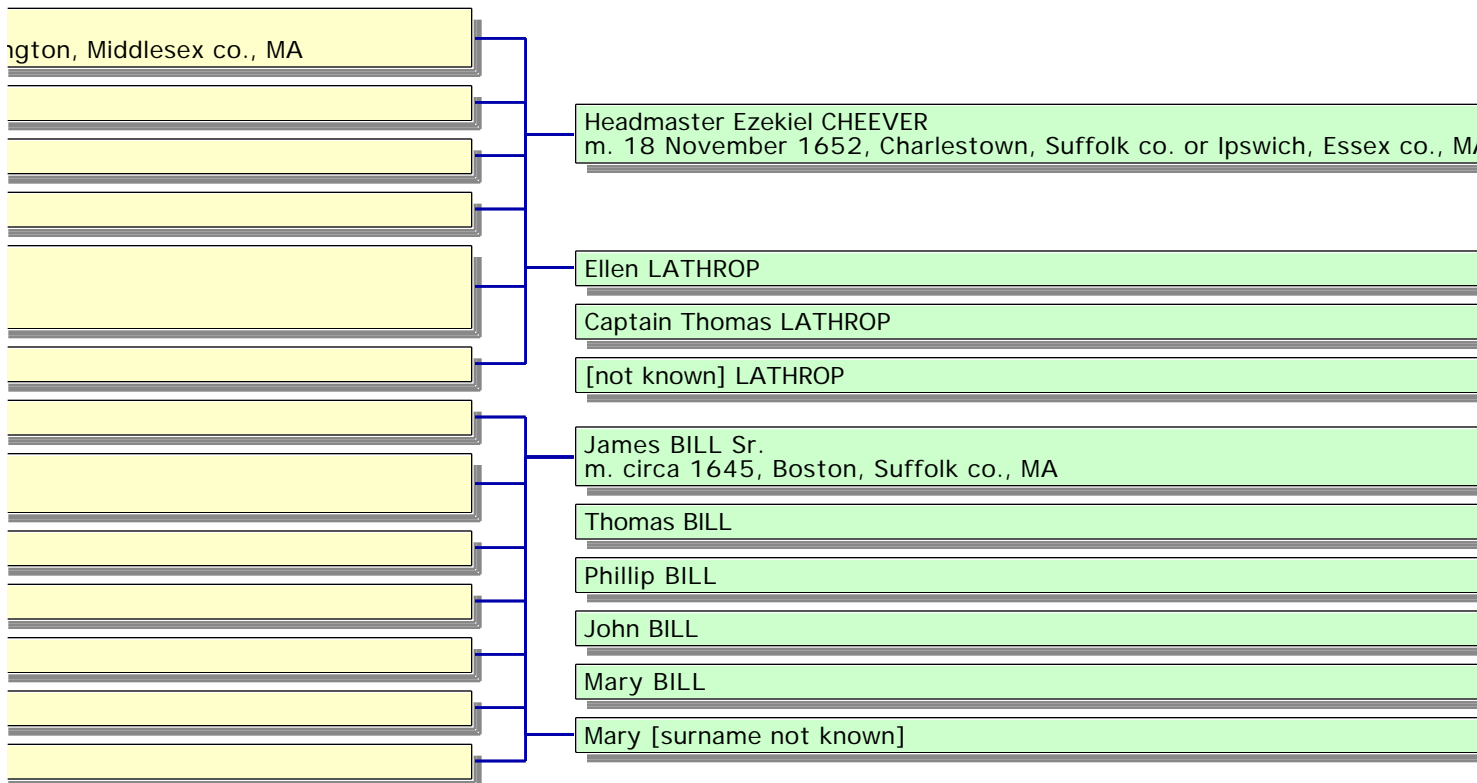
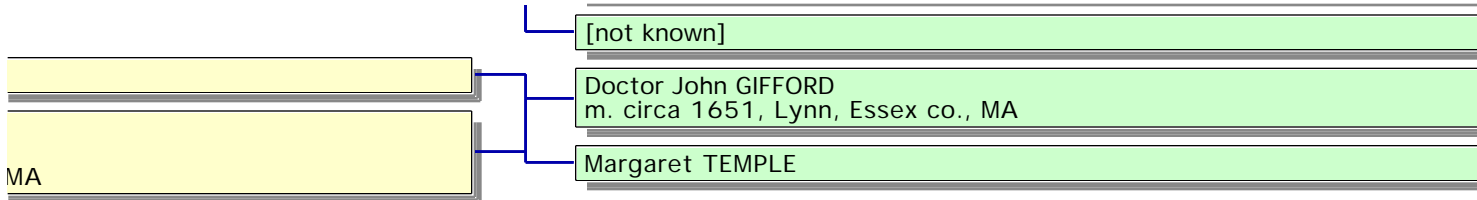

[Redacted]

[Redacted]

[Redacted]

[Redacted]

[Redacted]

[Redacted]

[Redacted]

[Redacted]

[Redacted]

[Redacted]

[Redacted]

[Redacted]

[Redacted]

[Redacted]

[Redacted]

[Redacted]

[Redacted]

[Redacted]

MA

MA

MA

/ Major Dennison

verly, Essex co., MA

A

Edward GILES
m. 6 October 1635, Salem, Essex co., MA

Bridget [surname not known]

Edmund GROVER
m. before 1628, England

Margaret [surname not known]

Roger HASKELL

Cecile/Cicille HASKELL
& Edward COKE
mp. Pen Selwood, Wiltshire, England

Captain William HASKELL
m. 6 November 1643, Gloucester, Essex co., MA

Mark HASKELL

Dorothy HASKELL

Elizabeth HASKELL

Joan HASKELL

[possibly Edward] HASKELL

Mary TIBBOT

Elizabeth TIBBOT
& [not known] DICKE

[unknown daughter] TIBBOT
& Edward CLARKE

Elinor TIBBOT
& James BAPSENE

John1 HAWKES

John2 HAWKES
m. 11 April 1661, Lynn, Essex co., MA

Susanna HAWKES
& William COGSWELL
m. 1649, Ipswich, Essex co., MA

Thomas CUSHMAN

Mary CUSHMAN

Sarah CUSHMAN

Issac CUSHMAN Reverend

Elkanah CUSHMAN Deacon

Fear CUSHMAN

Eleazar CUSHMAN

Lydia CUSHMAN

Walter WHITFORD
m. by 1668, Salem, Essex co., MA

Bridgett [surname not known]

Joseph SWASEY

Mary [surname not known]

Elizabeth NEWHALL
& Edmund FARRINGTON
m. 29 November 1613, Sherington, Buckinghamshire, England

Thomas NEWHALL
& Mary Jane PENDLETON? WOOD? WOODARD?
m. 12 June 1618, England

Francis NEWHALL

Anne NEWHALL
& Baldwin PARKER
m. 18 Jan 1635/6

Mary NEWHALL
& Raphael ROSE
m. 15 October 1635

Anthony NEWHALL
m. 6 November 1632, Olney, England

Mary WHITE

Essex co., MA

[Redacted]

A or Dorchester, Suffolk County, MA

[Redacted]

[Redacted]

[Redacted]

IA

[Redacted]

[Redacted]

A

[Redacted]

[Redacted]

[Redacted]

[Redacted]

[Redacted]

[Redacted]

[Redacted]

A

[Redacted]

co., MA

[Redacted]

[Redacted]

o., MA

IA

[Redacted]

Henry COLLINS, Senior
m. before 1629, St. Dunstan, Stepney Parish, Middlesex, England

Ann RIAL/ROYAL

Thomas TOLMAN Sr.
m. before 1632, Dorchester, Suffolk co., MA

Sarah [surname not known]

Robert RAND Sr.
m. before 1653, Lynn, Essex co., MA

[Redacted]

Elizabeth [surname not known]

[Redacted]

[Redacted]

[not known] FRENCH

Thomas LOTHROP

Mary [surname not known]

[Redacted]

Andrew STEVENSON
mp. England

Jane [surname not known]

[Redacted]

[Redacted]

[Redacted]

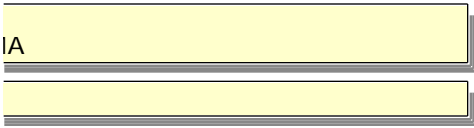
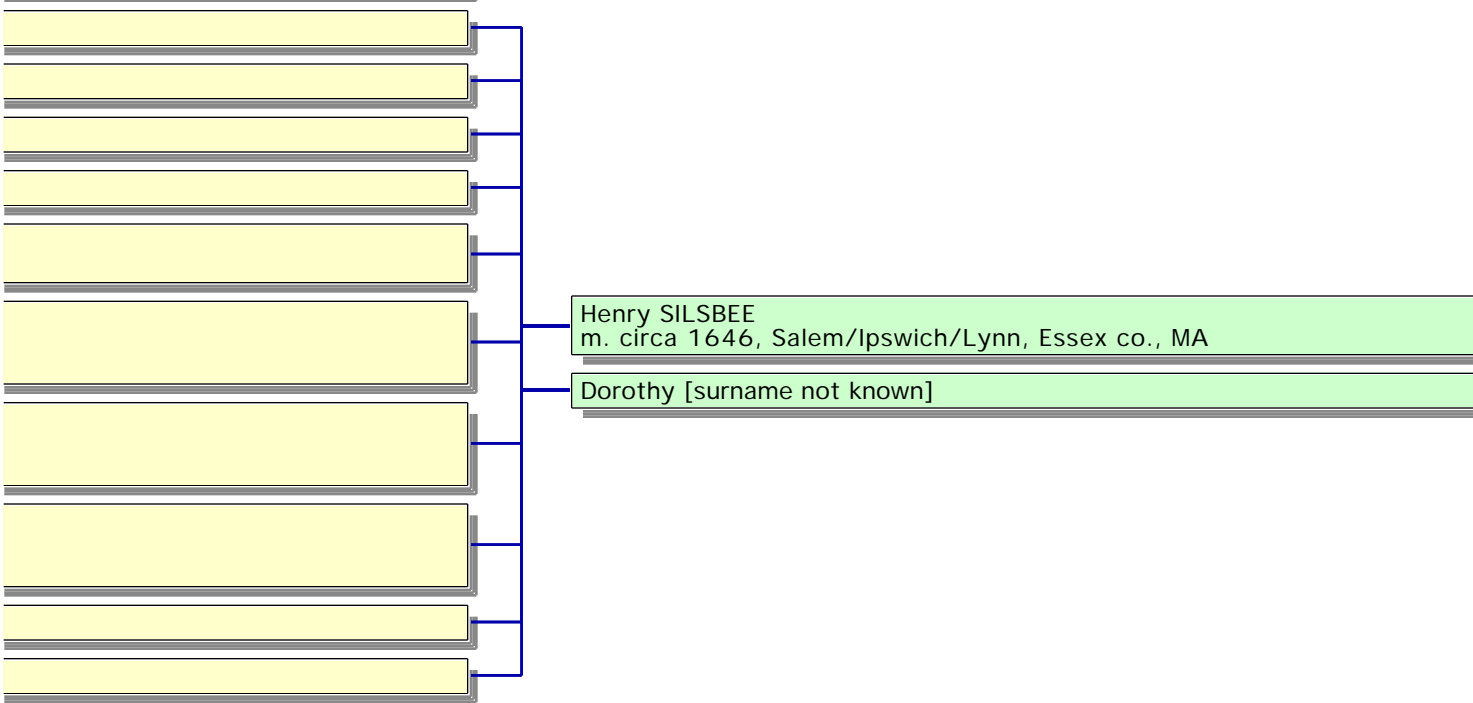
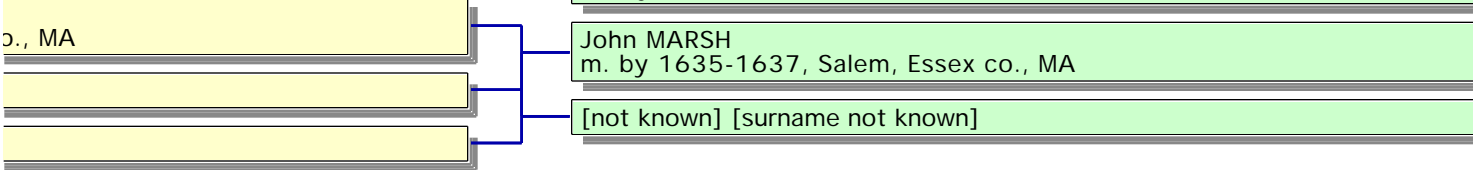
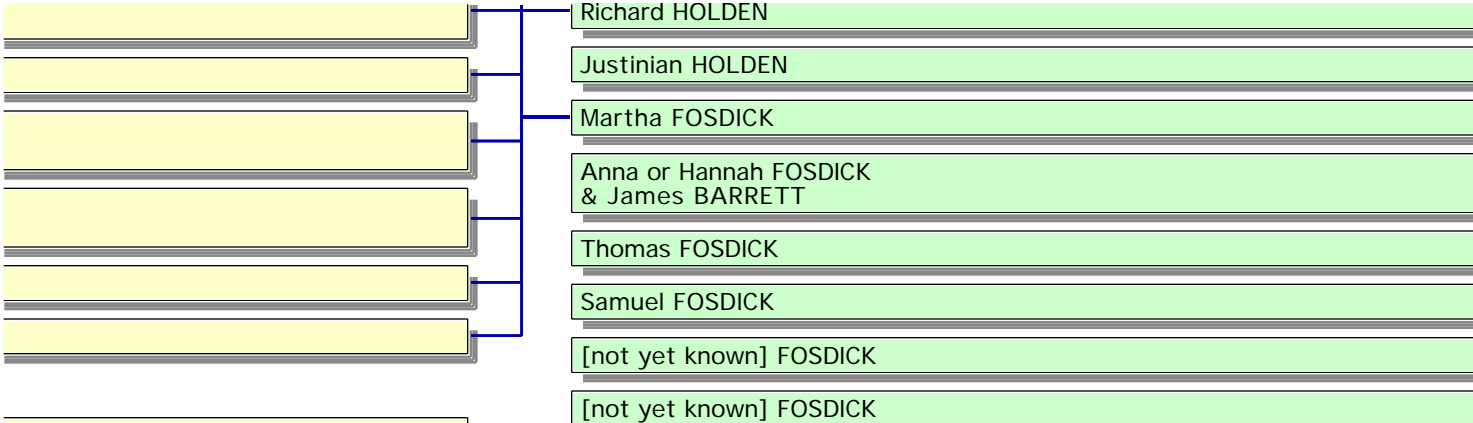

A

MA

- John MOWER
m. 21 July 1673, Lynn, Essex co., MA
- Samuel MOWER
& Joanna MARSHALL
m. before 1676, Lynn, Essex co., MA
- Thomas MOWER
- Mary MOWER
& [not known] CHILLE
- Hannath MARSHALL
& Jonathon LEWIS
m. 17d:4m:1659, Lynn, Essex co., MA
- Samuel MARSHALL
- Abigail MARSHALL
- Sarah1 MARSHALL
- Thomas1 MARSHALL
- Elizebeth MARSHALL
- Thomas2 MARSHALL
- Susannah MARSHALL
- Sarah2 MARSHALL
& Ebenezur STOCKER
m. 15 July 1674, Lynn, Essex co., MA
- Joanna MARSHALL
& Samuel MOWER
m. before 1676, Lynn, Essex co., MA
- John MARSHALL
- Ruth MARSHALL
- Mary MARSHALL
& Edward BAKER
m. 7 April 1685, Lynn, Essex co., MA
- Shubael SEAVER
m. 7 February 1668/9, Roxbury, Suffolk co., MA
- Caleb SEAVER
& Sarah INGLESBY
m. 15 December 1671, Charlestown, Suffolk co., MA
- Joshua SEAVER
& Mary [surname not known]
m. 28 February 1677/8, Roxbury, Suffolk co., MA
- Elizabeth SEAVER
& Samuel CRAFTS
m. 16 October 1661, Roxbury, Suffolk co., MA
- Nathaniel SEAVER
& Sarah [surname not known]
m. before 1671, Roxbury, Suffolk co., MA
- Hannah2 SEAVER
- Hannah1 SEAVER
- Hannah WILSON

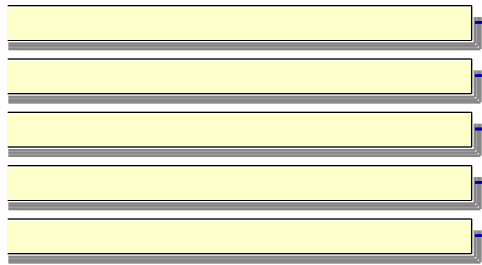

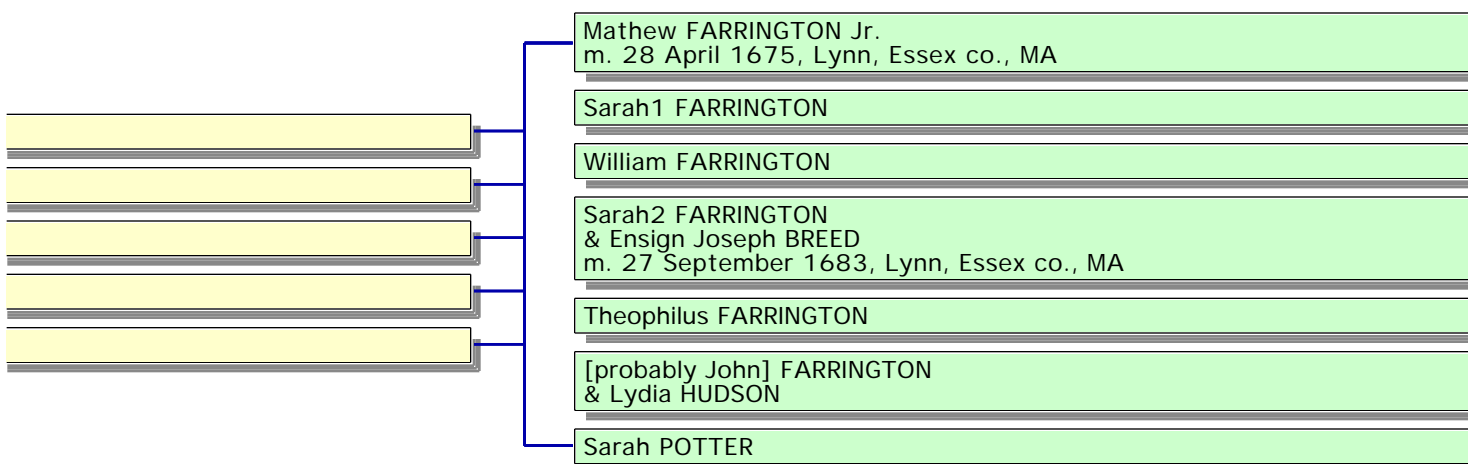
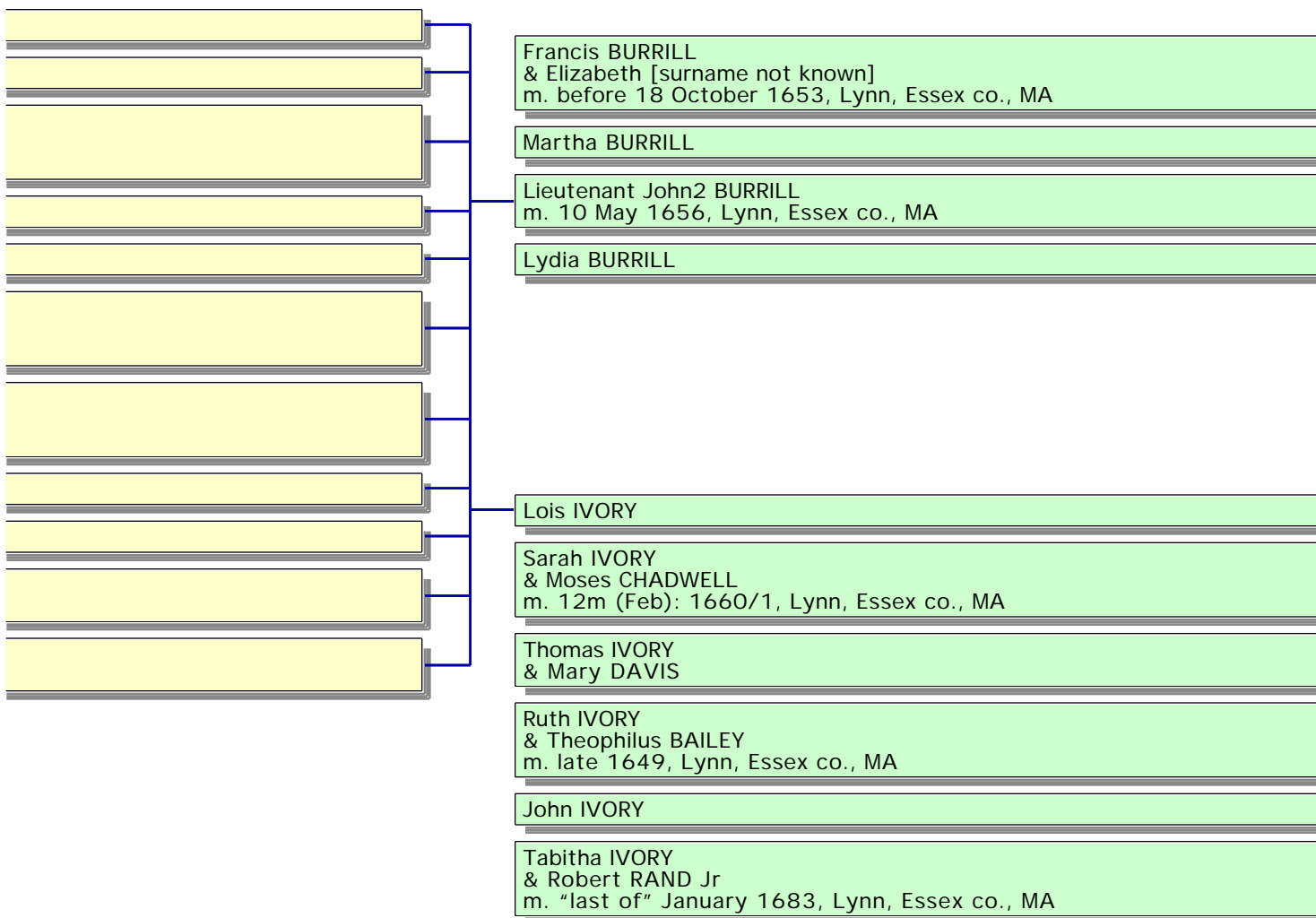

Allen BREED
m. circa 1654, Lynn, Essex co., MA

Elizabeth BREED
& William MERRIAM

Timothy BREED

Joseph BREED

John BREED
& Sarah HATHORNE
& Sarah HART

[Yellow box]

IA [Yellow box]

[Yellow box]

[Yellow box]

[Yellow box]

[Yellow box]

IA [Yellow box]

Mary SARGENT

Sarah SARGENT

Richard HOOD Sr.
m. circa 1652, Lynn, Essex co., MA

[Yellow box]

[Yellow box]

[Yellow box]

[Yellow box]

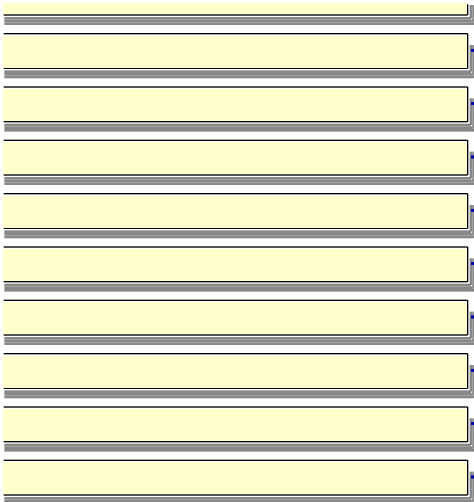

John NEWHALL Jr.
& Elizabeth NORMANTON
m. 31d:10m (December):1656/7, Lynn, Essex co., MA

Mary NEWHALL

Elizabeth BASSETT
& John PROCTER
m. 1 April 1674, Salem, Essex co., MA
& Daniel RICHARDS
m. 22 September 1699, Lynn, Essex co., MA

Sarah BASSETT
& Thomas ELWELL
m. 23 November 1675, Gloucester, Essex co., MA

William BASSETT Jr.
m. 25 October 1675, Lynn, Essex co., MA

John BASSETT

Miriam BASSETT
& Ephriam SANDIN
m. before 1681

ex co., MA

Mary BASSETT
& Michael DERICH/DERRICK/RICH
m. circa 1676

Hannah1 BASSETT

x co., MA

Elisha BASSETT

Samuel BASSETT

Rachell BASSETT
& Ephriam SILSBY
m. 23 January 1693/4, Salem, Essex co., MA

Hannah2 BASSETT
& John LILLE

Rebecca BASSETT

Mary HOOD

Richard HOOD, Jr.
& Hannah BERRY
m. circa 1688

Sarah HOOD

Elizabeth HOOD

Ruth HOOD

Rebecca HOOD

John HOOD

Hannah HOOD

Samuel HOOD
Nathaniel HOOD
Anna HOOD
& Samuel BREED
m. 5 February 1691/2, Lynn, Essex co., MA
Joseph HOOD
Benjamin HOOD

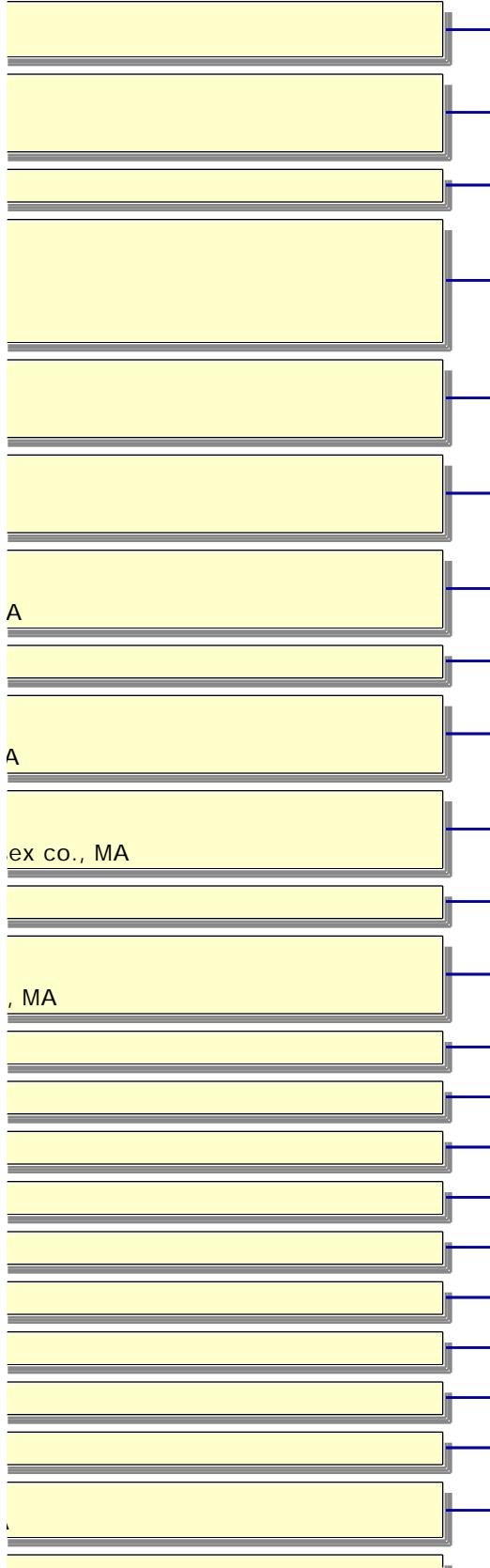

Thaddeus BERRY
m. circa 1664, Rumney Marsh, Suffolk, co. MA or Lynn, Essex co., MA
Hanna FARRAR
Susanna FARRAR
& Ensign Joseph NEWHALL
m. circa 1678, Lynn, Essex co., MA
& Benjamin SIMONS
m. 26 September 1713, Lynn, Essex co., MA
Thomas FARRAR
& Abigail COLLINS
m. 3 March 1680/1, Lynn, Essex co., MA
& Elizabeth HOOD
m. 6 December 1682, Lynn, Essex co., MA
Peleg FARRAR
Mehitabel FARRAR
Elizabeth FARRAR
Sarah FARRAR

Edward WOODMAN Jr.
m. 20 December 1653, Newbury, Essex co., MA
Sarah WOODMAN
Mary GOODRIDG

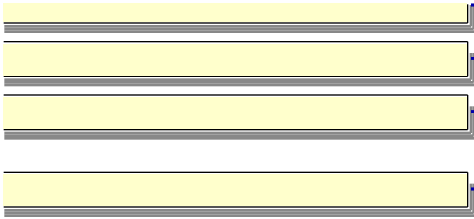

Samuell SAWYER
m. 13 March 1670/1, Newbury, Essex co., MA

Mary EMERY

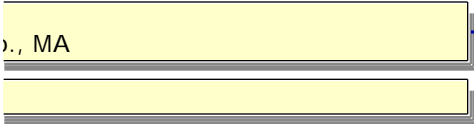

James SAUNDERS

Sarah PAGE

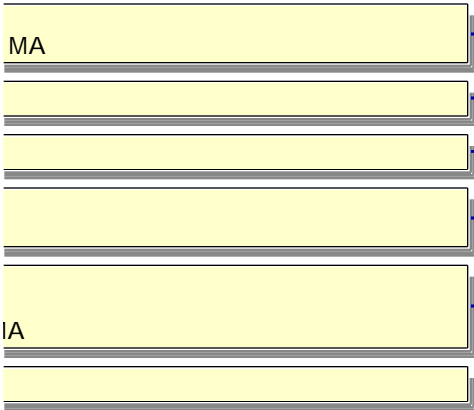

Susanna SCALES
& Benjamin SCOTT
m. 28 December 1676, Rowley, Essex co., MA

James SCALES
m. 7 November 1677, Rowley, Essex co., MA

Caleb CURTIS

Sarah1 CURTIS

Richard CURTIS

Sarah2 CURTIS

Hanna CURTIS
& Richard FRIEND
m. 19d:2m:1677, Salem, Essex co., MA

John1 CURTIS

John2 CURTIS

Mary CURTIS

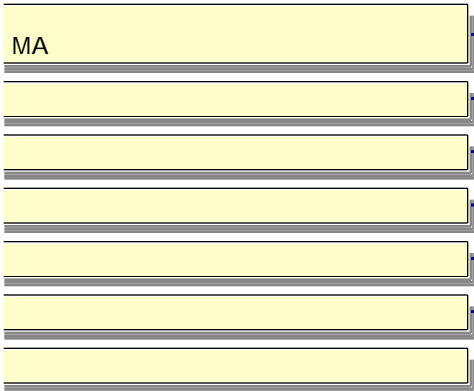

Stephen BARNARD
m. 1 May 1671, Andover, Essex co., MA

Rebecka HOW

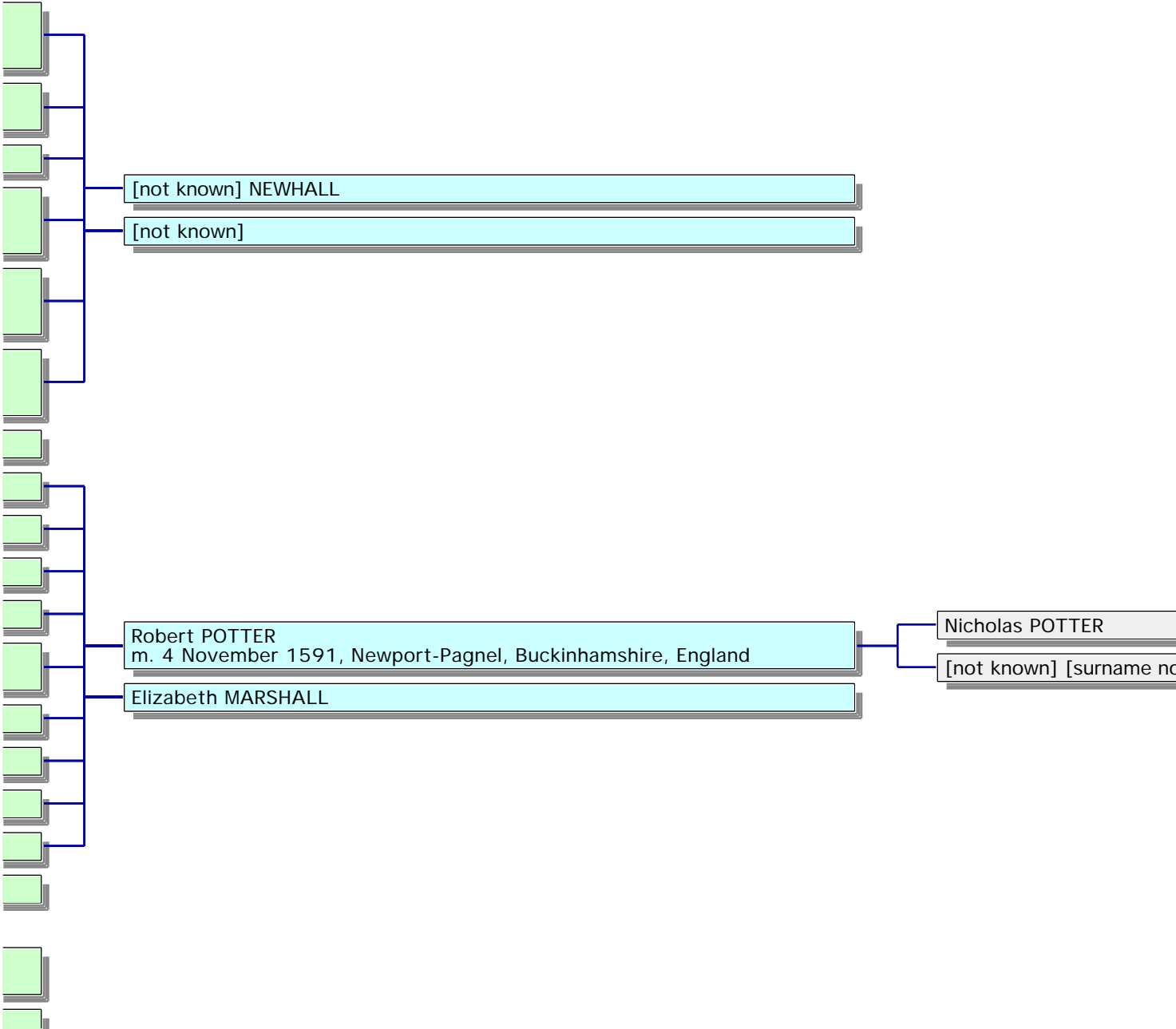

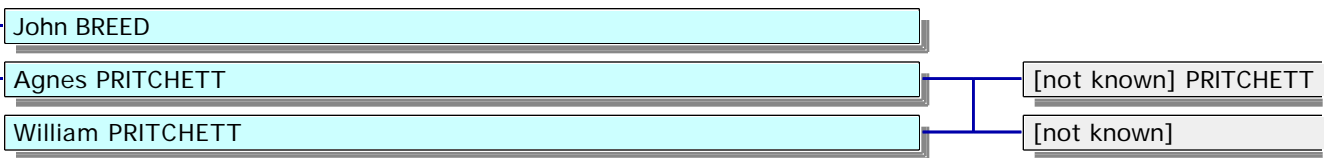
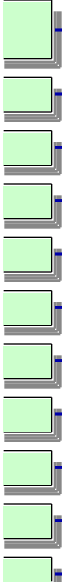

Thomas WHEELER

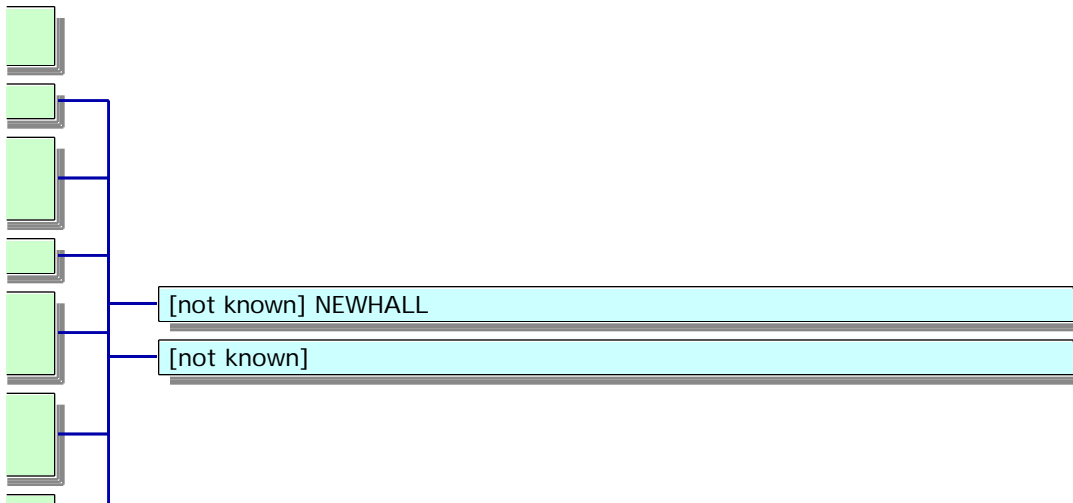
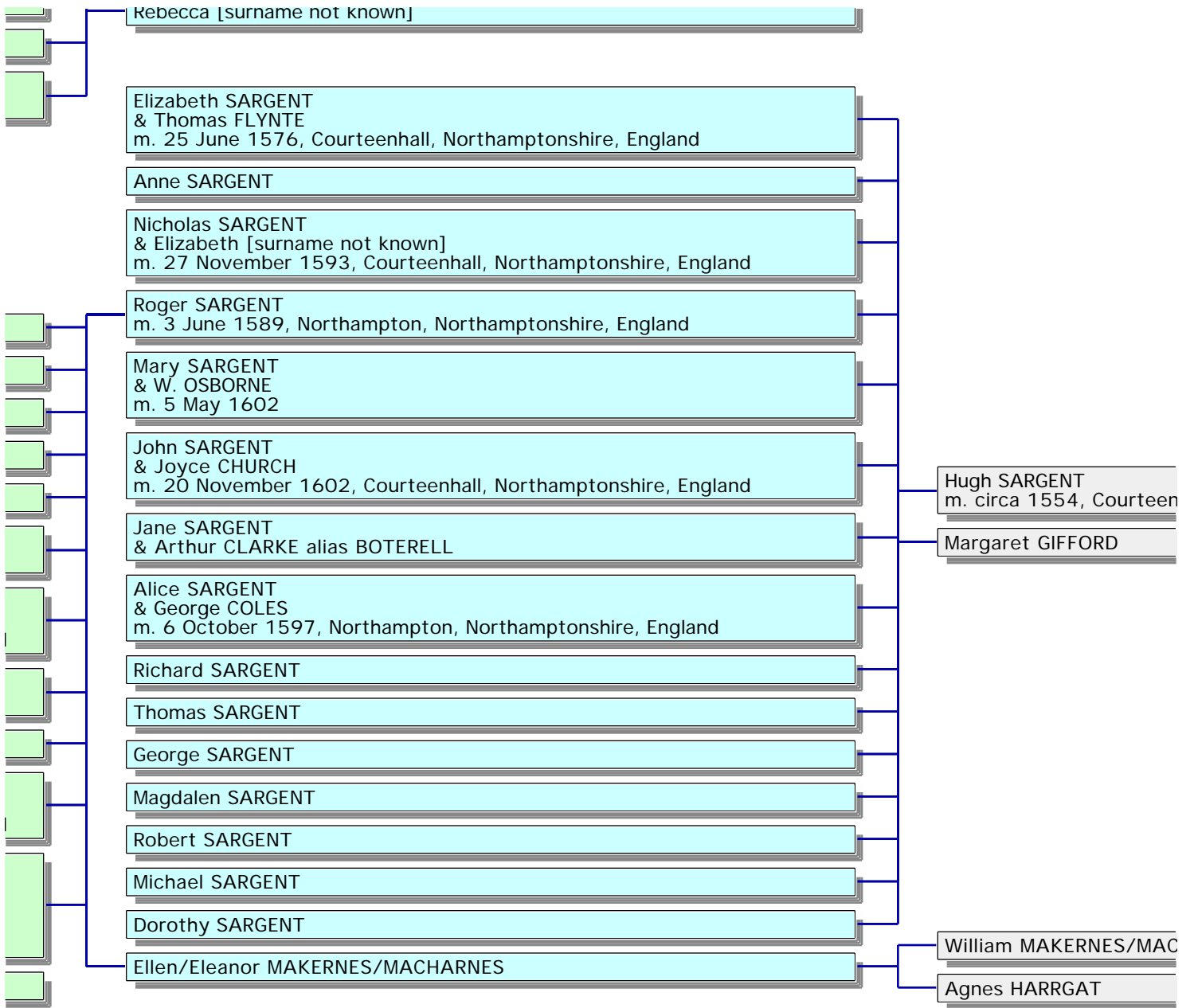

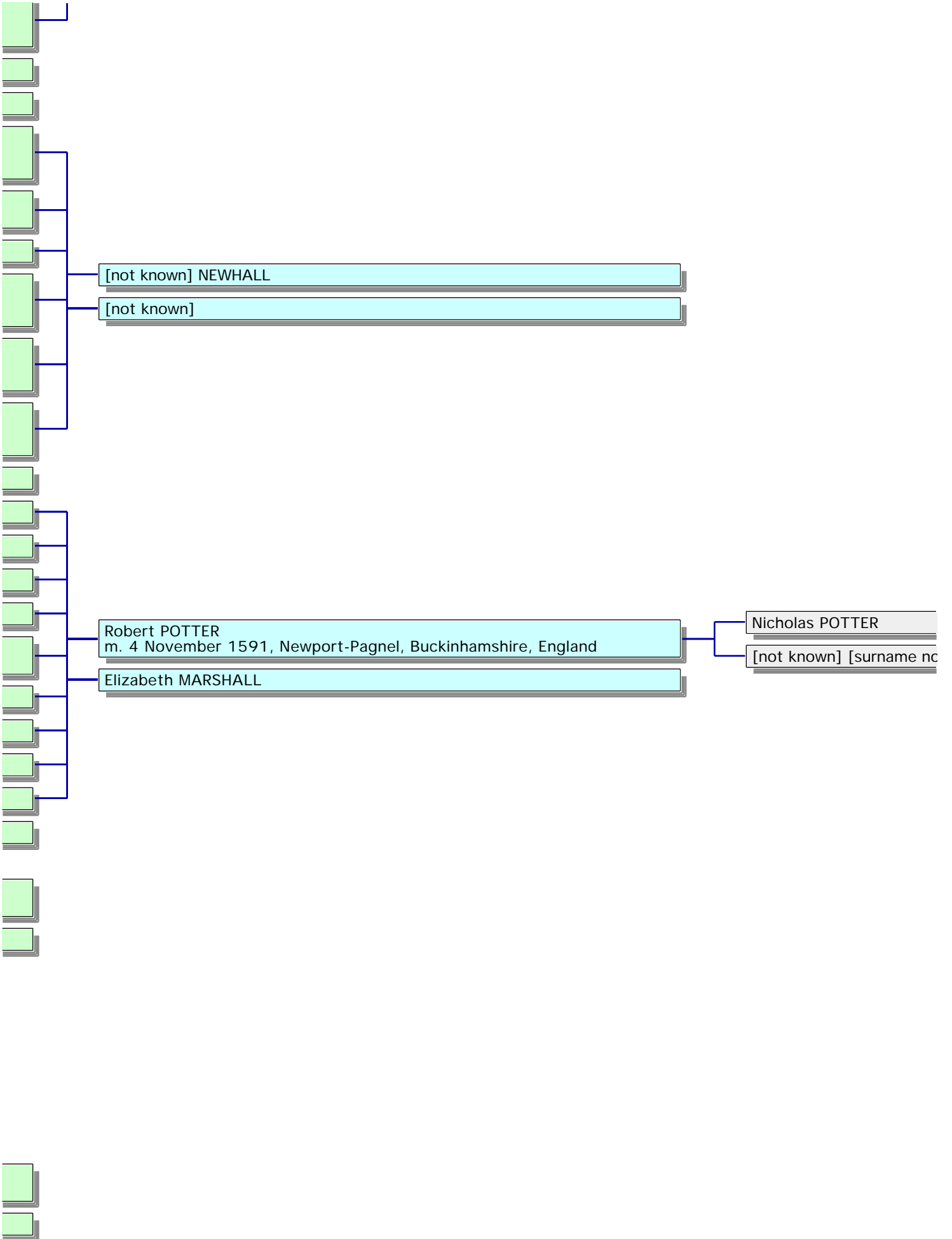

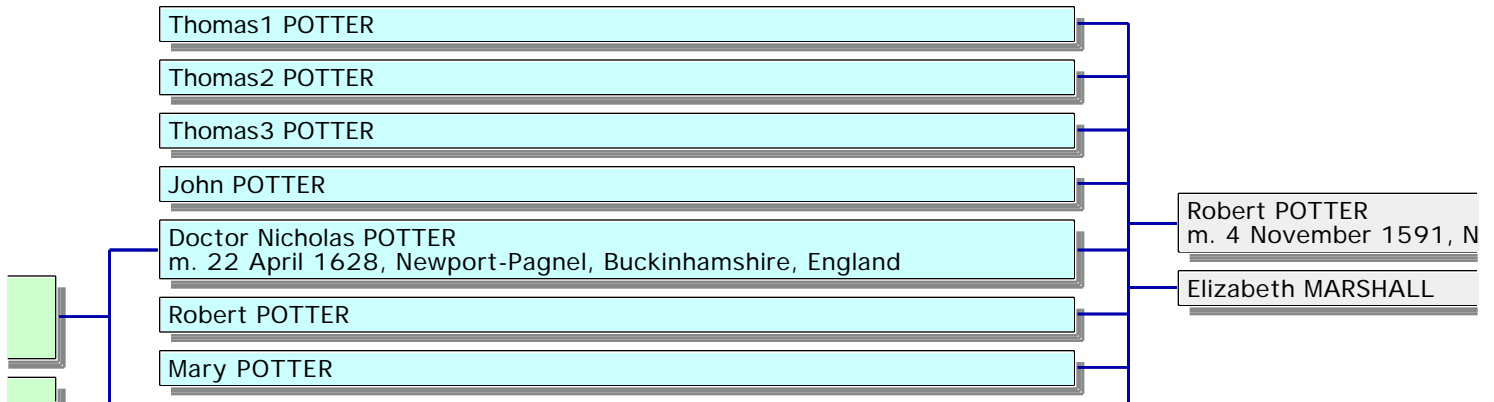
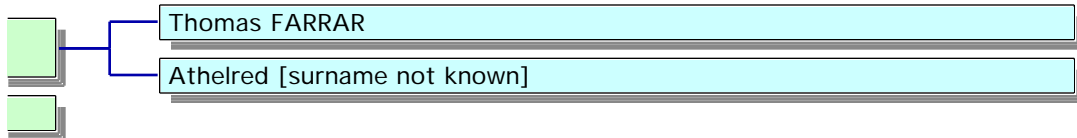
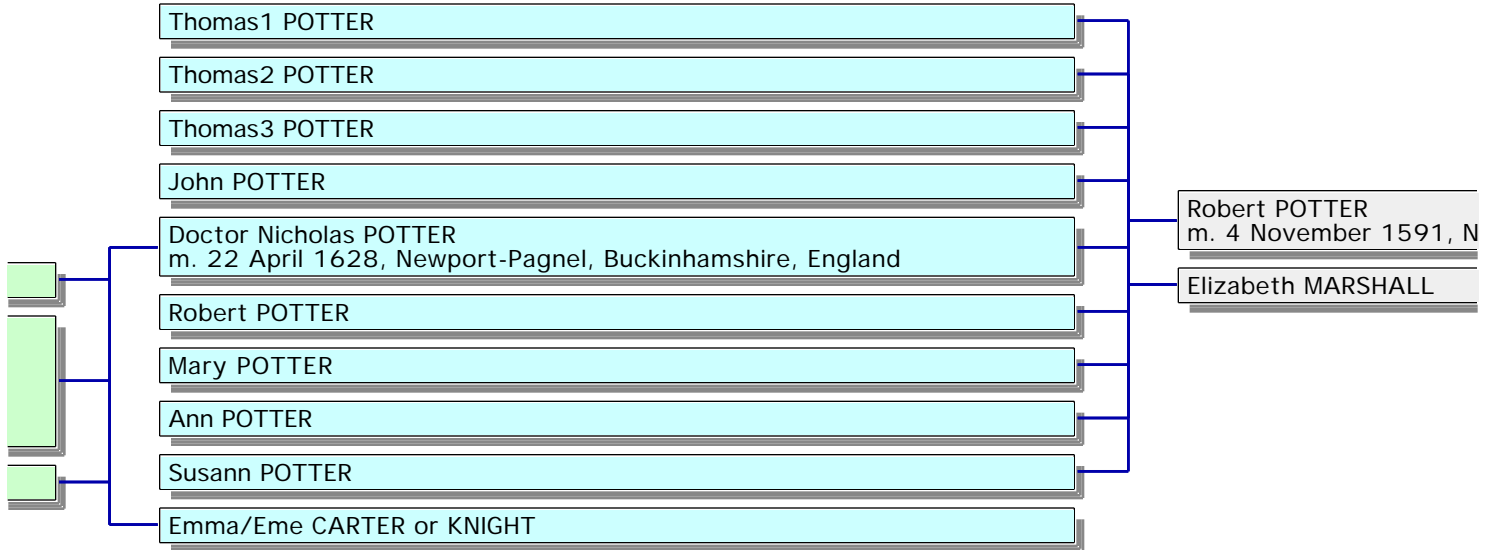
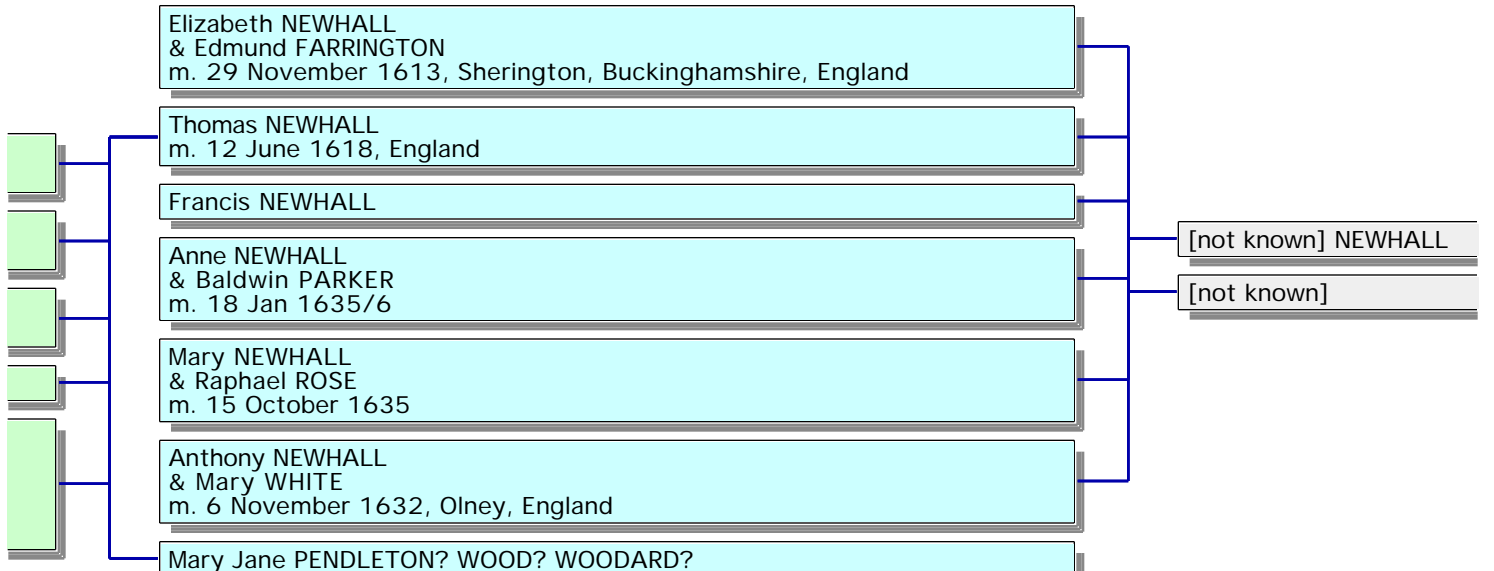

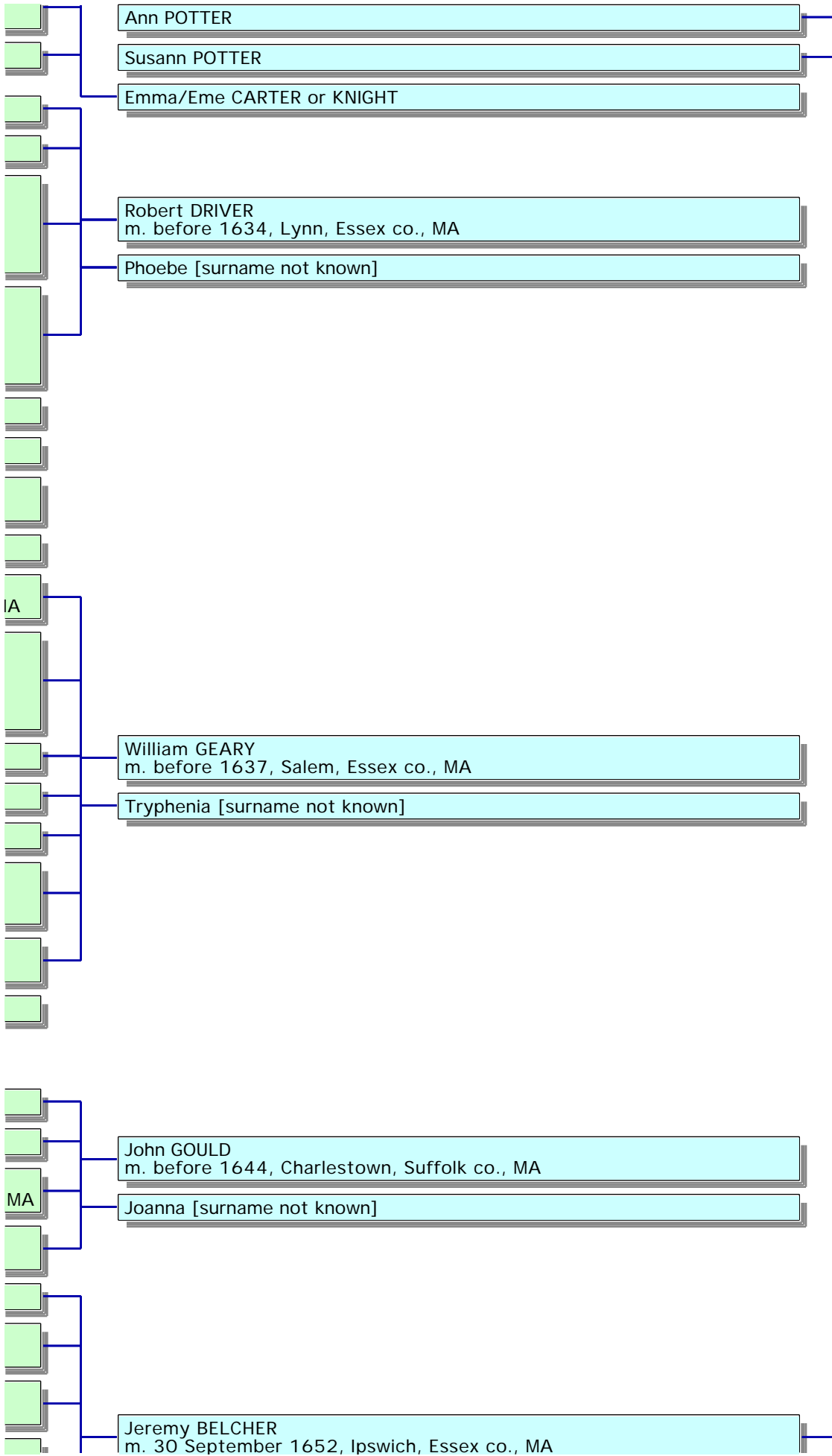

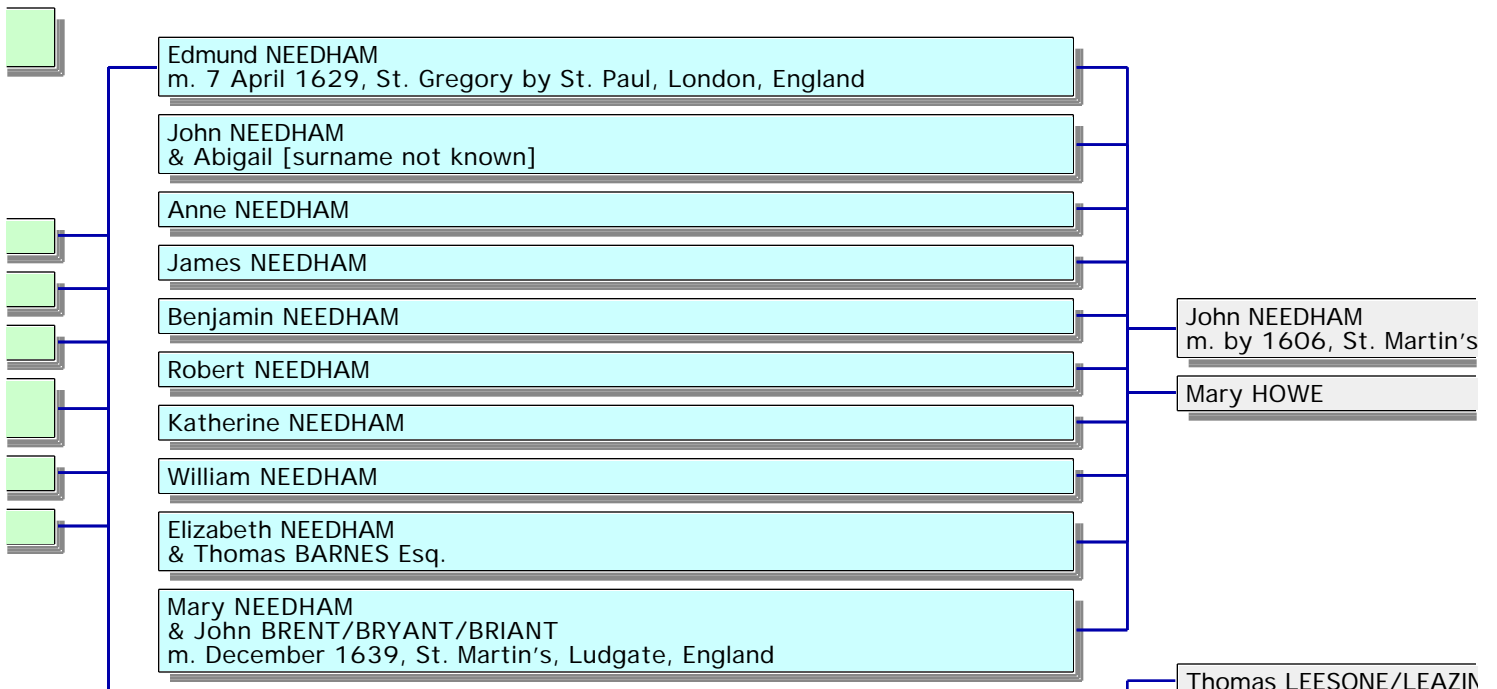
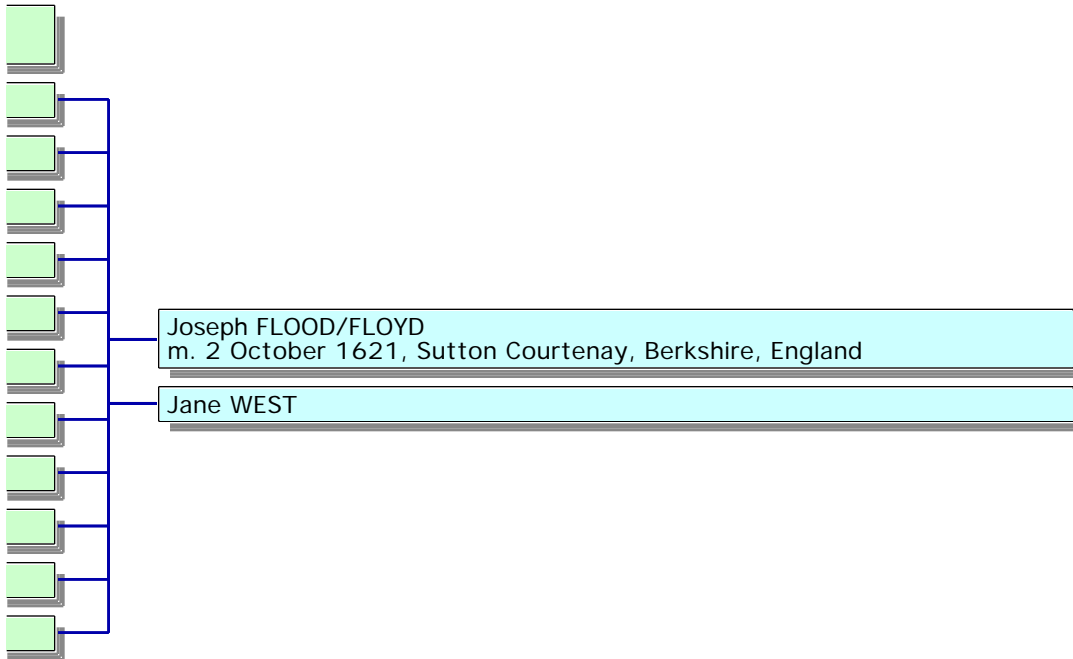
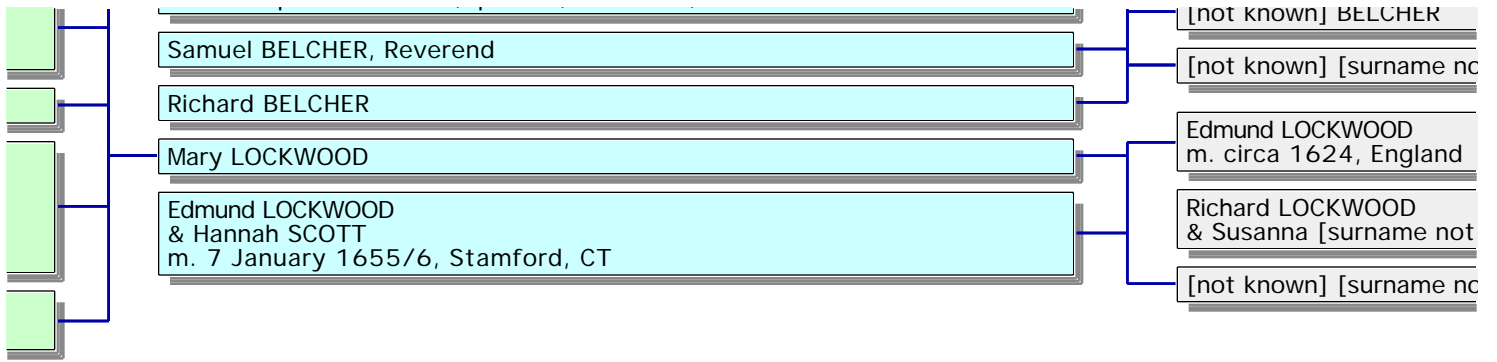

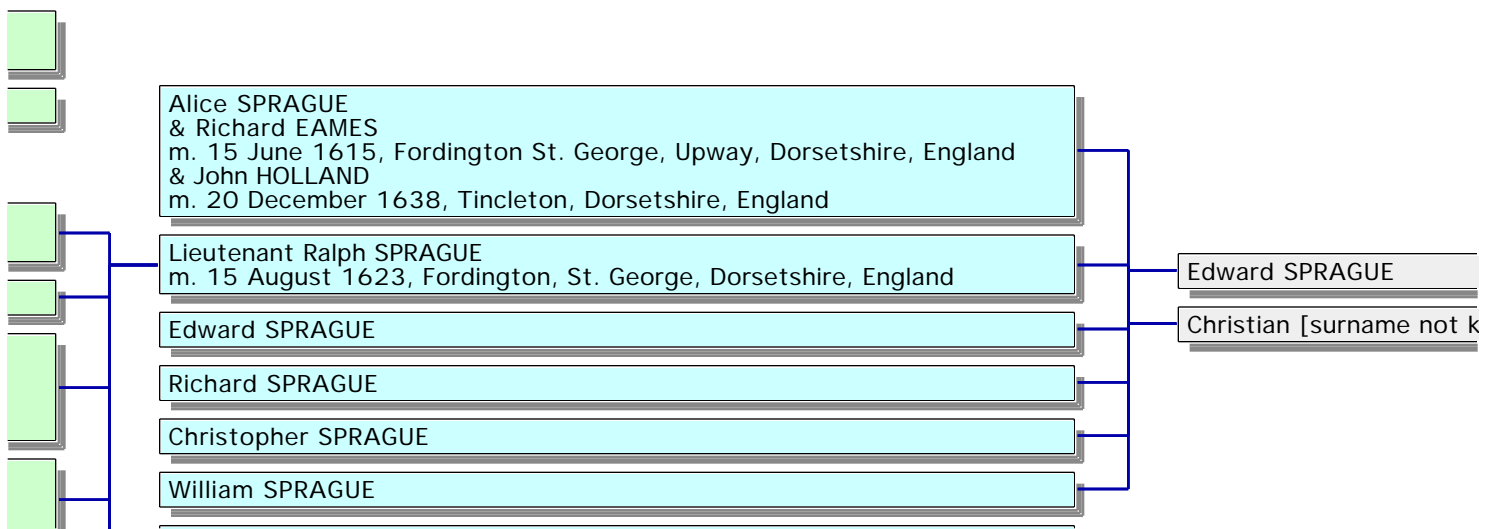
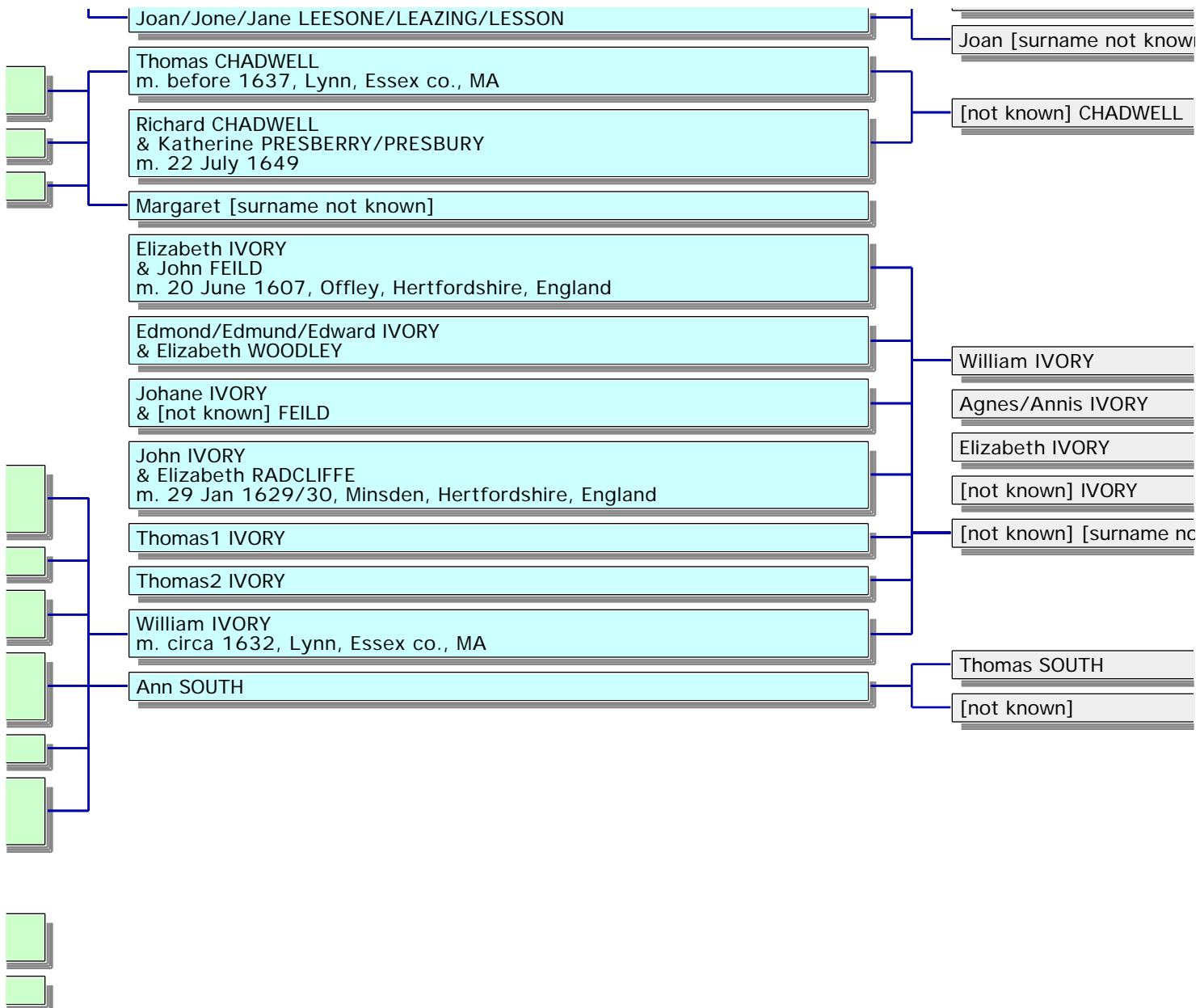

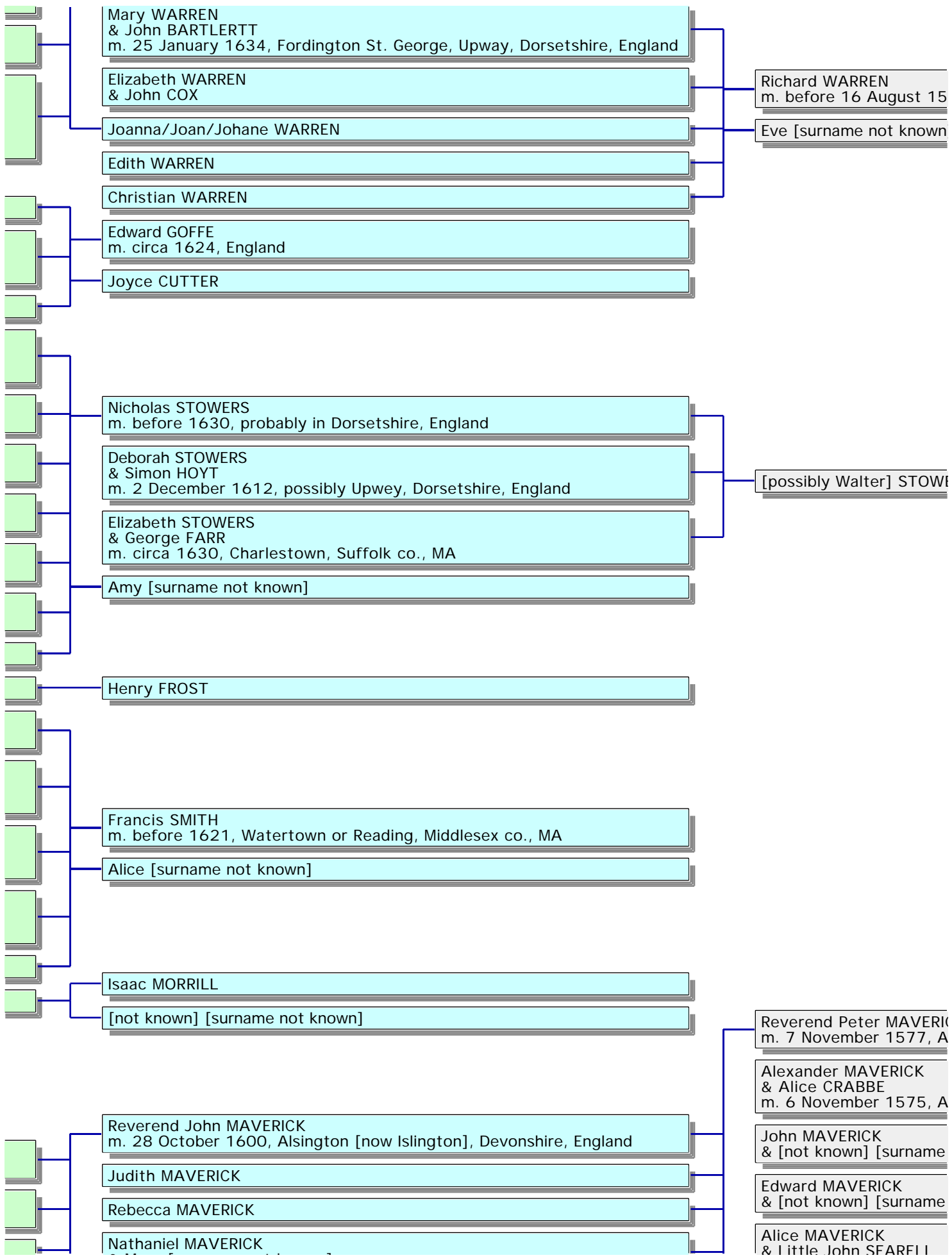

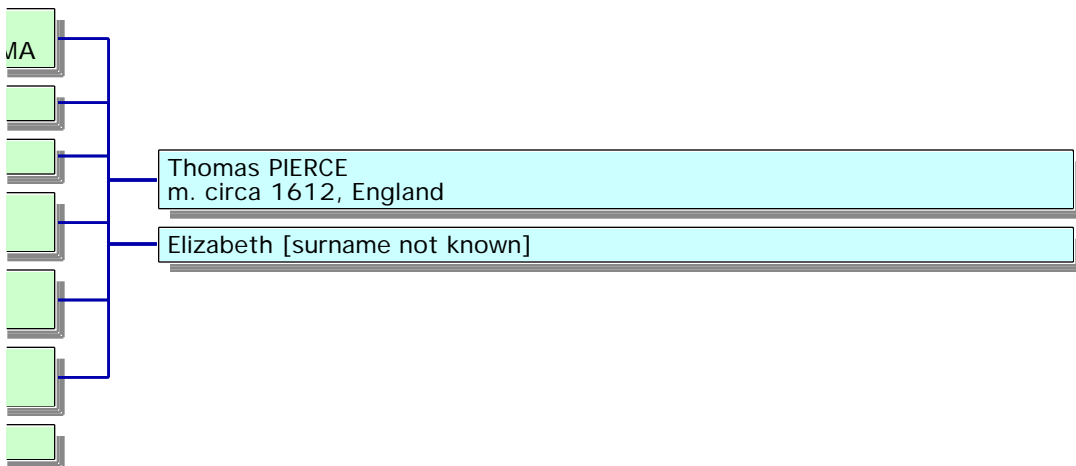
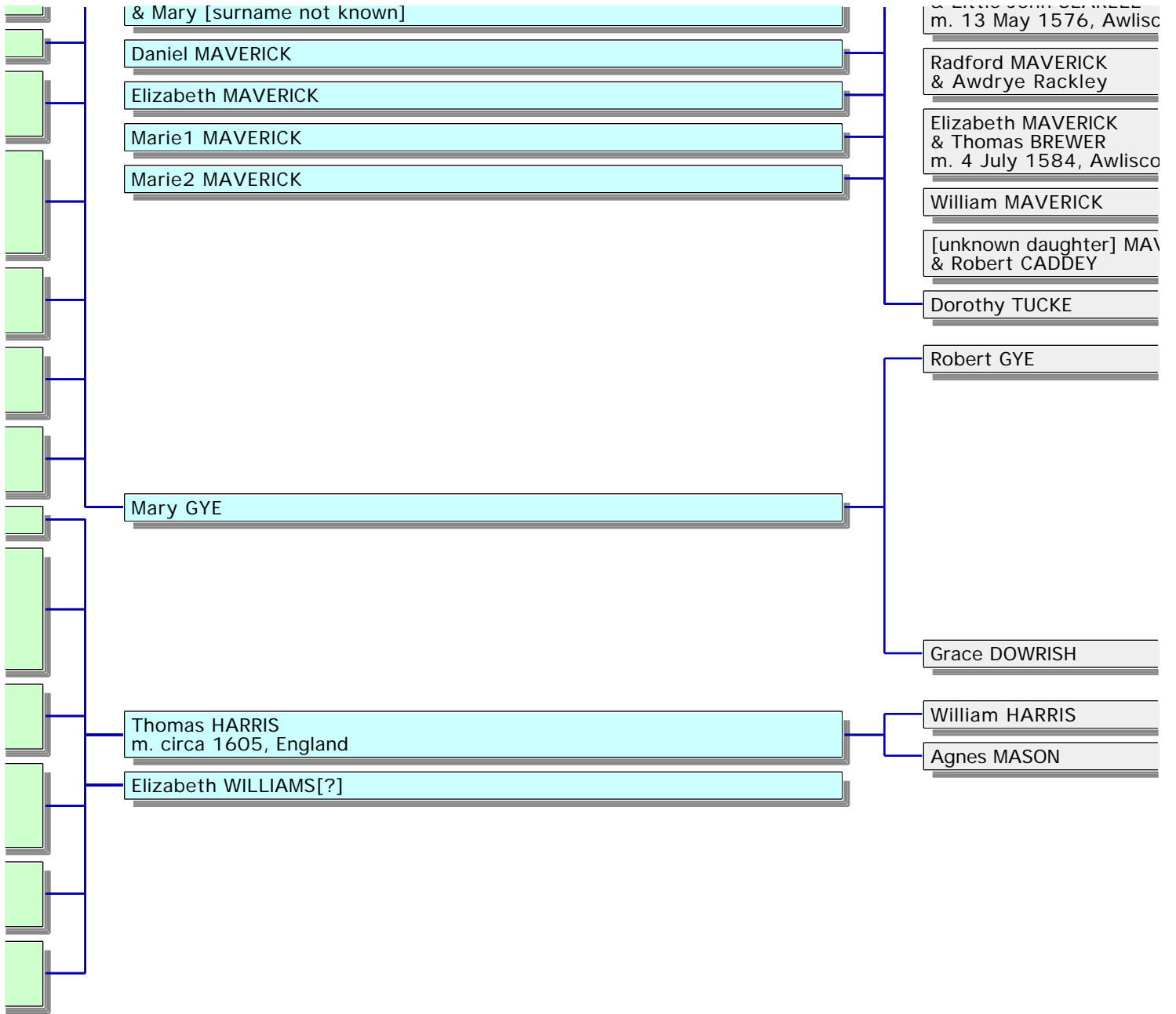

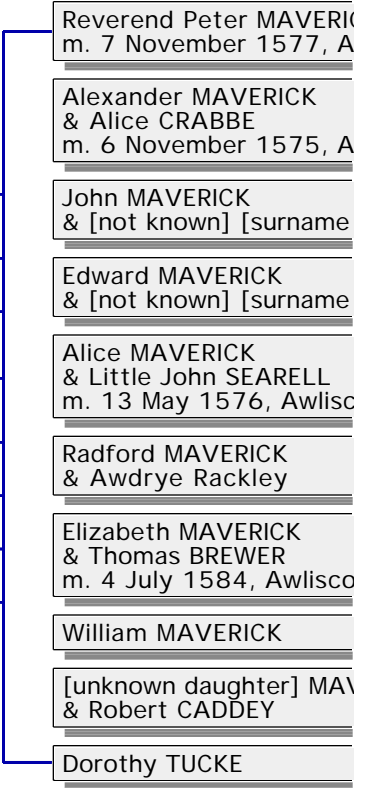
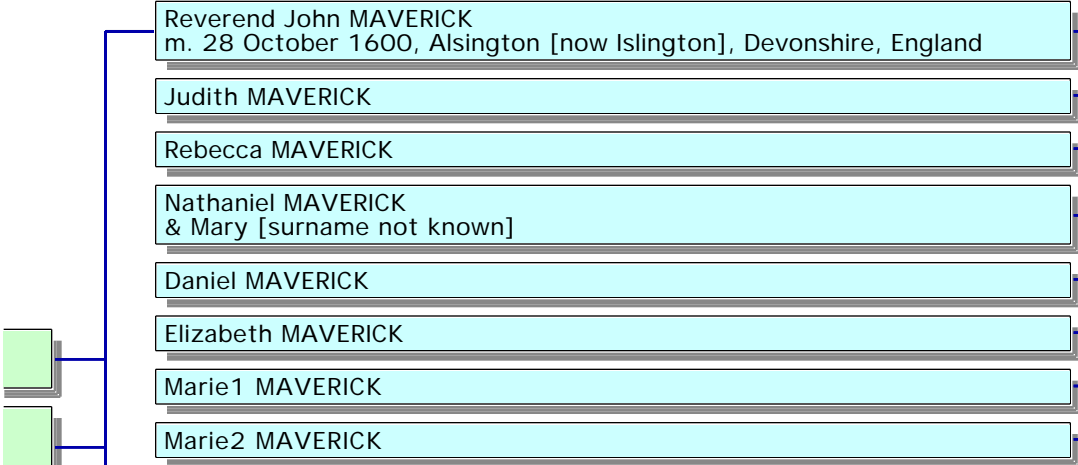
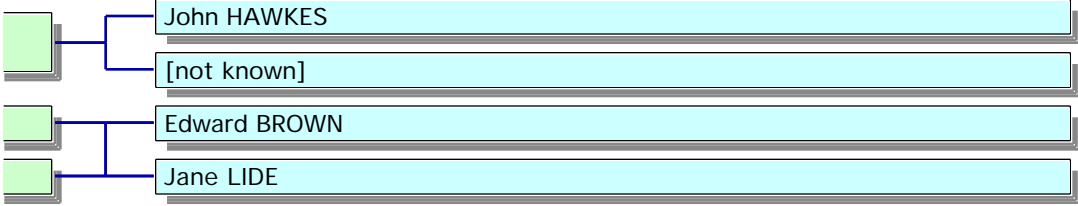

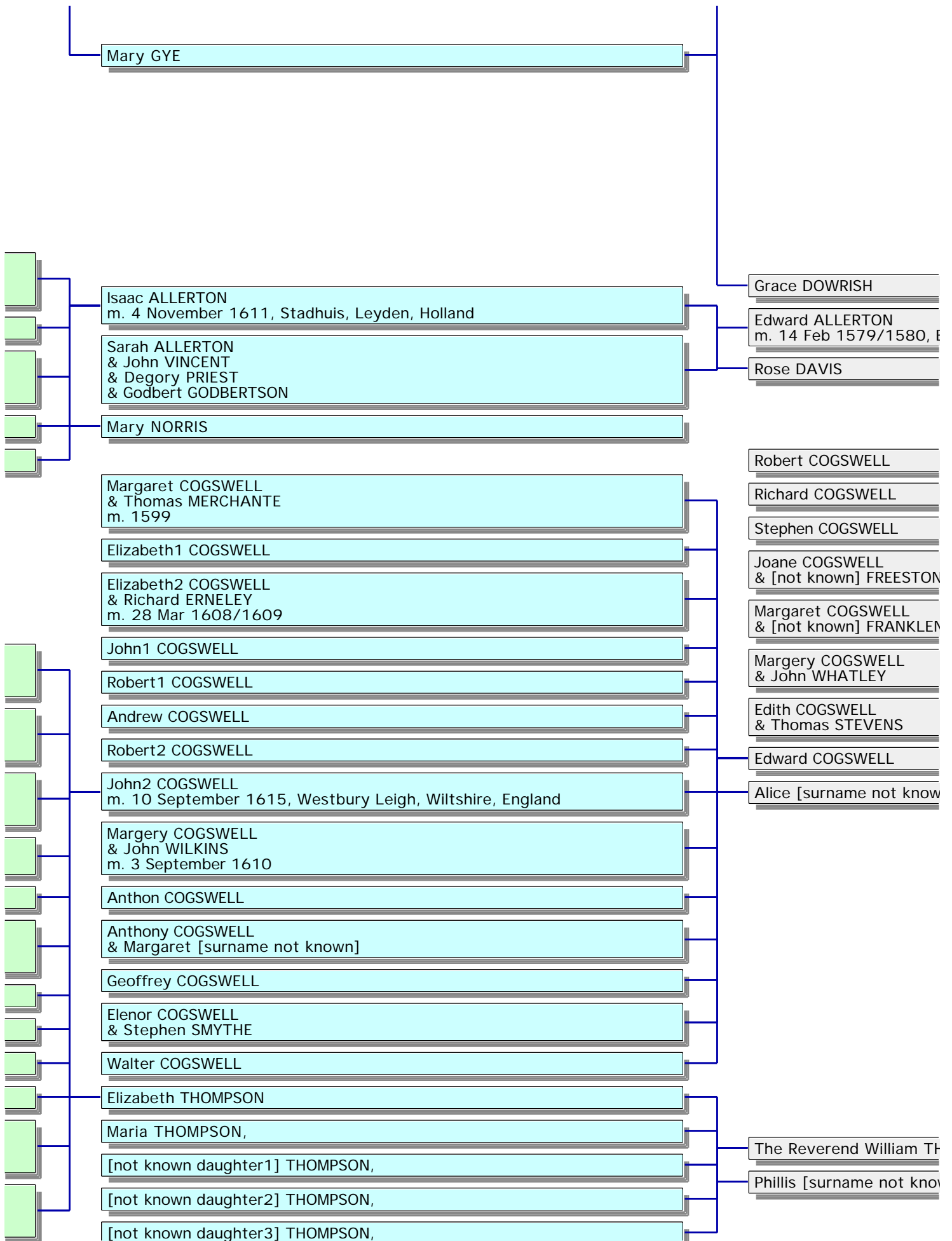

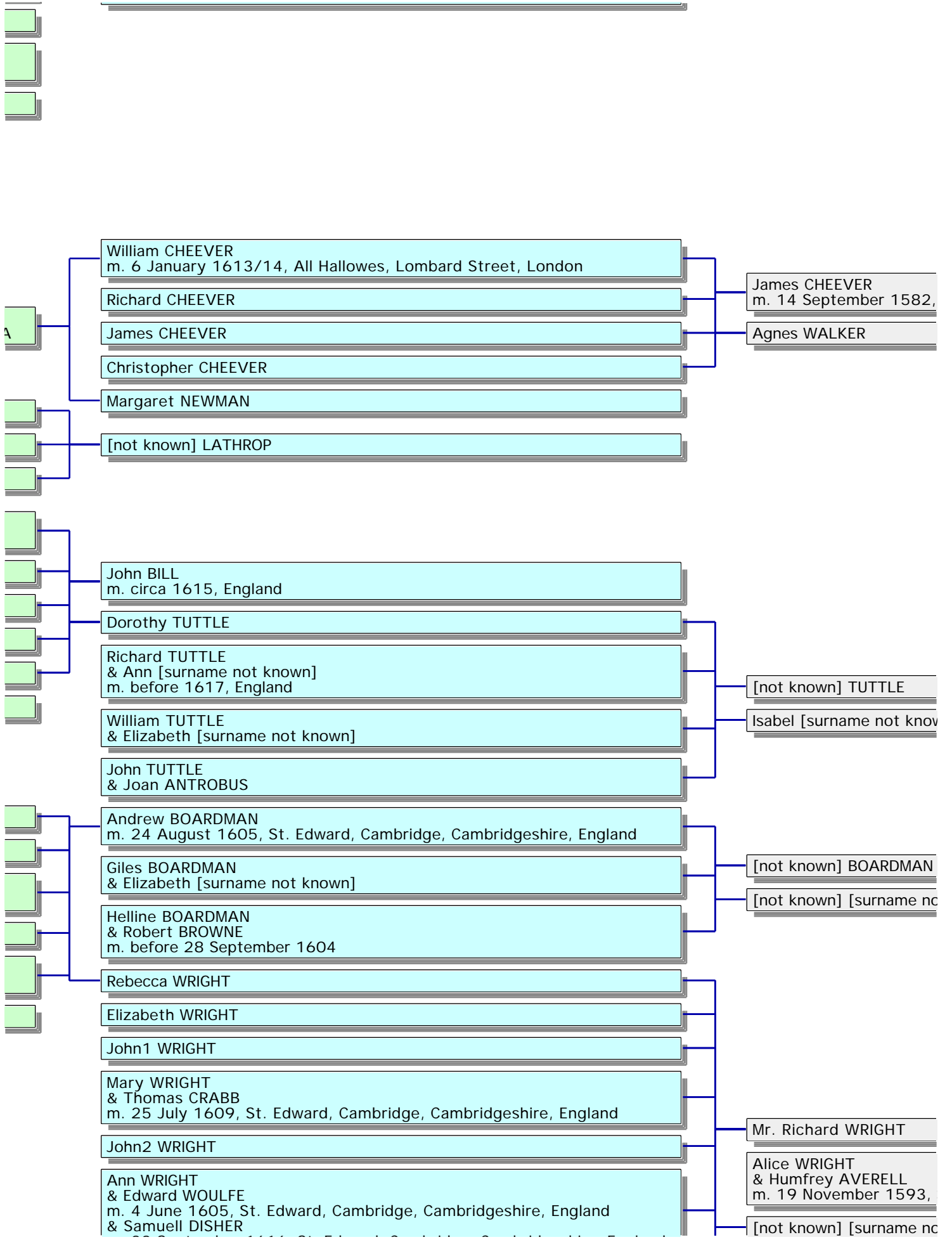

m. 22 September 1616, St. Edward, Cambridge, Cambridgeshire, England

Anthonie WRIGHT

Susanna WRIGHT

Abell WRIGHT

Richard WRIGHT

MA

Samuel WAITE

Mary WARD

Reverend John WARD

Joseph HILLS

[not known] WARD

Deacon Thomas LYNDE
m. before 1615, England

Mary [surname not known]

MA

Thomas PIERCE
m. circa 1612, England

Elizabeth [surname not known]

—

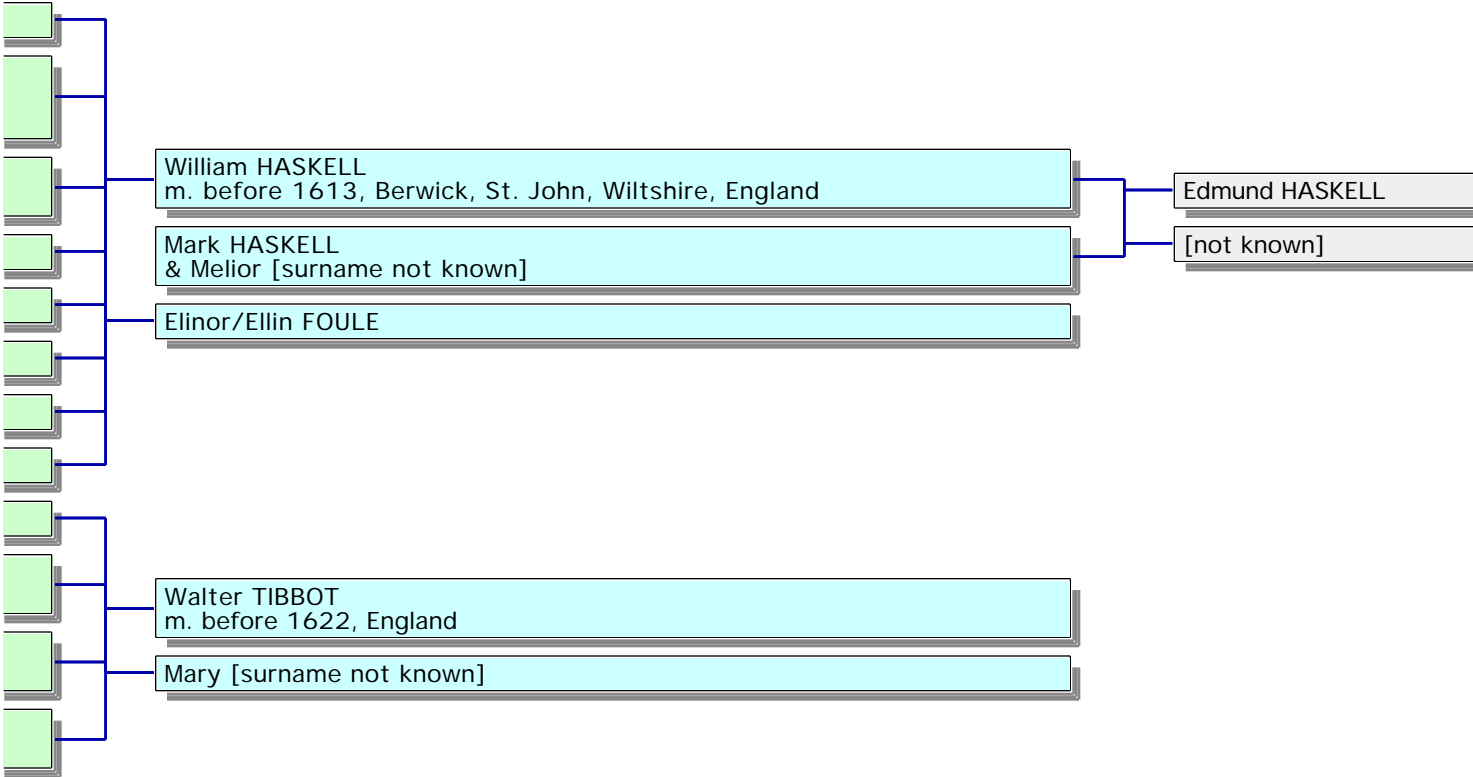

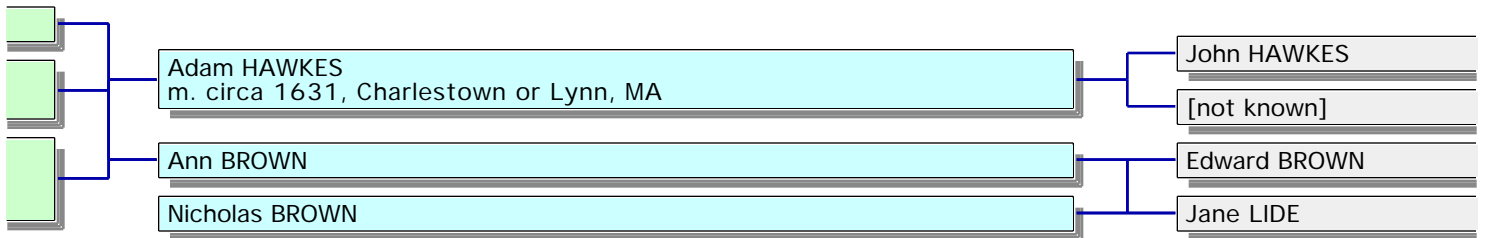

Alys CUSHMAN

Sylvester CUSHMAN
& Stephen EVERENDEN
m. 7 November 1593, R

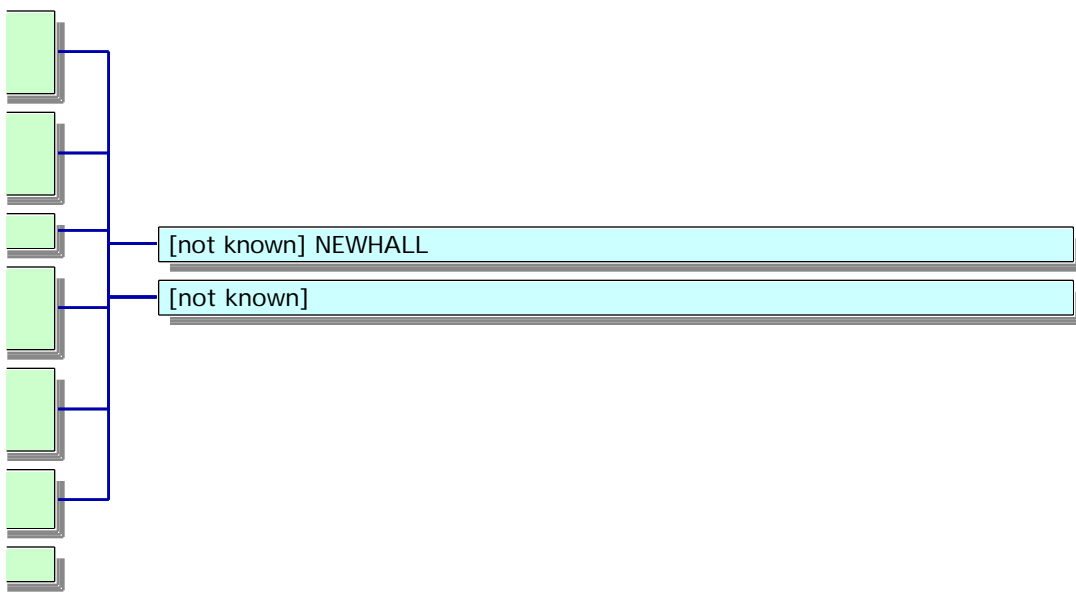
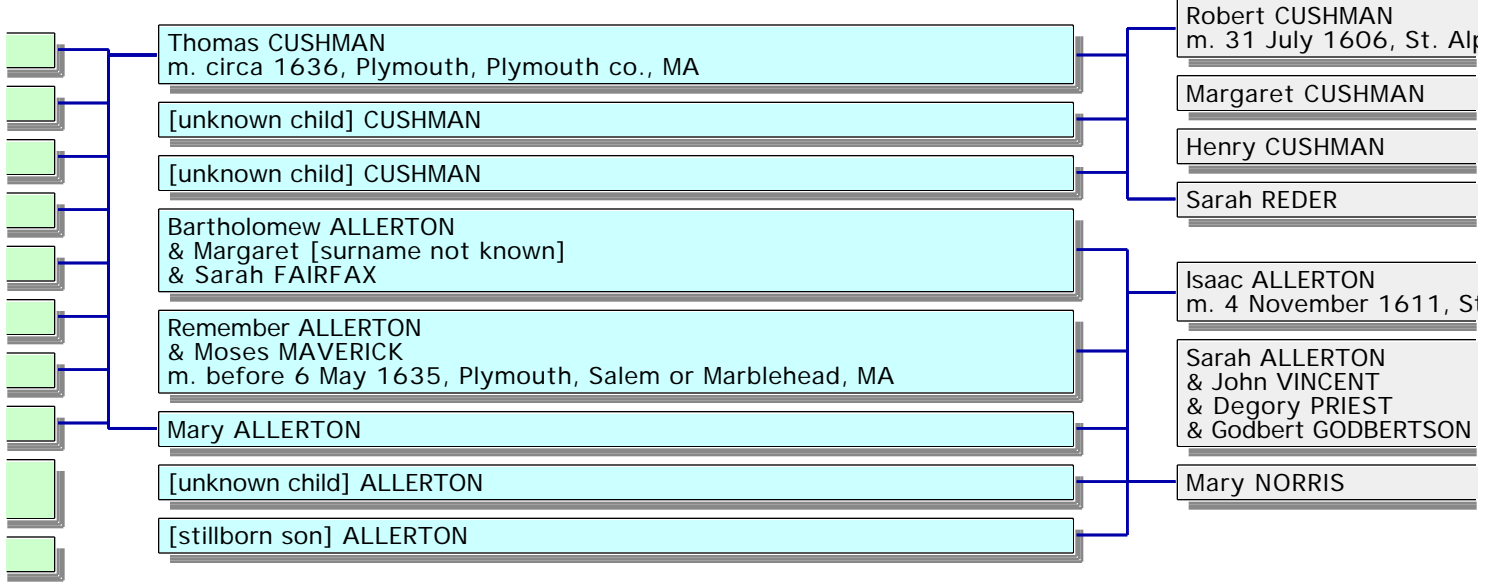

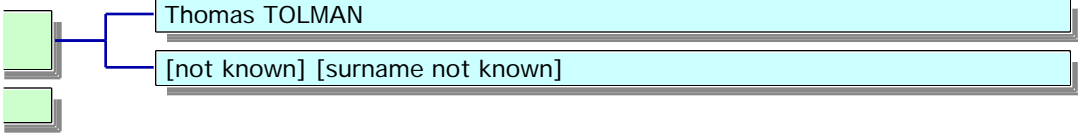
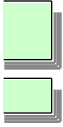



Reverend John LOTHROP
m. 10 October 1610, England

Hannah HOUSE



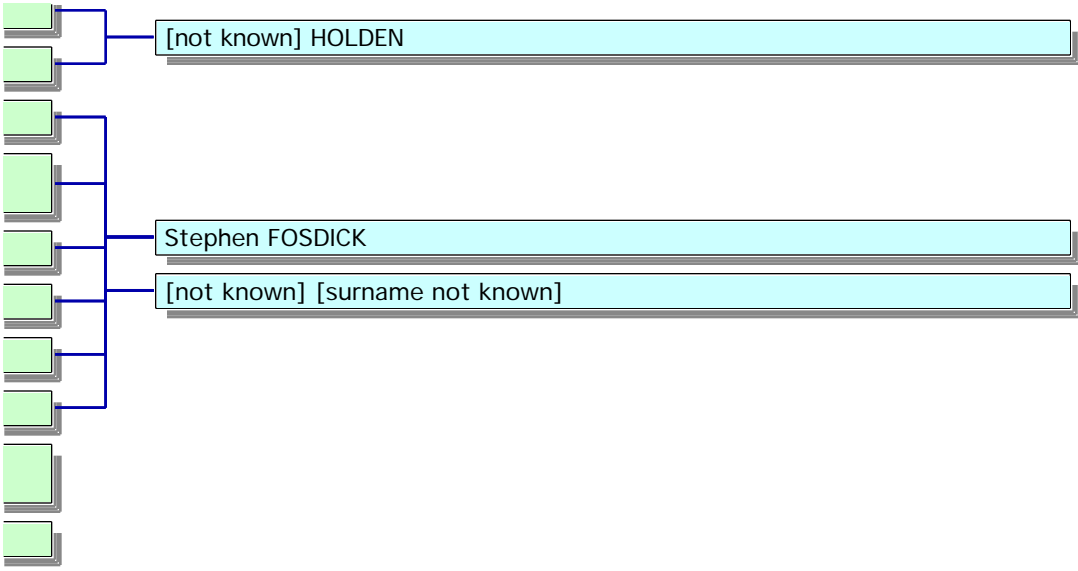

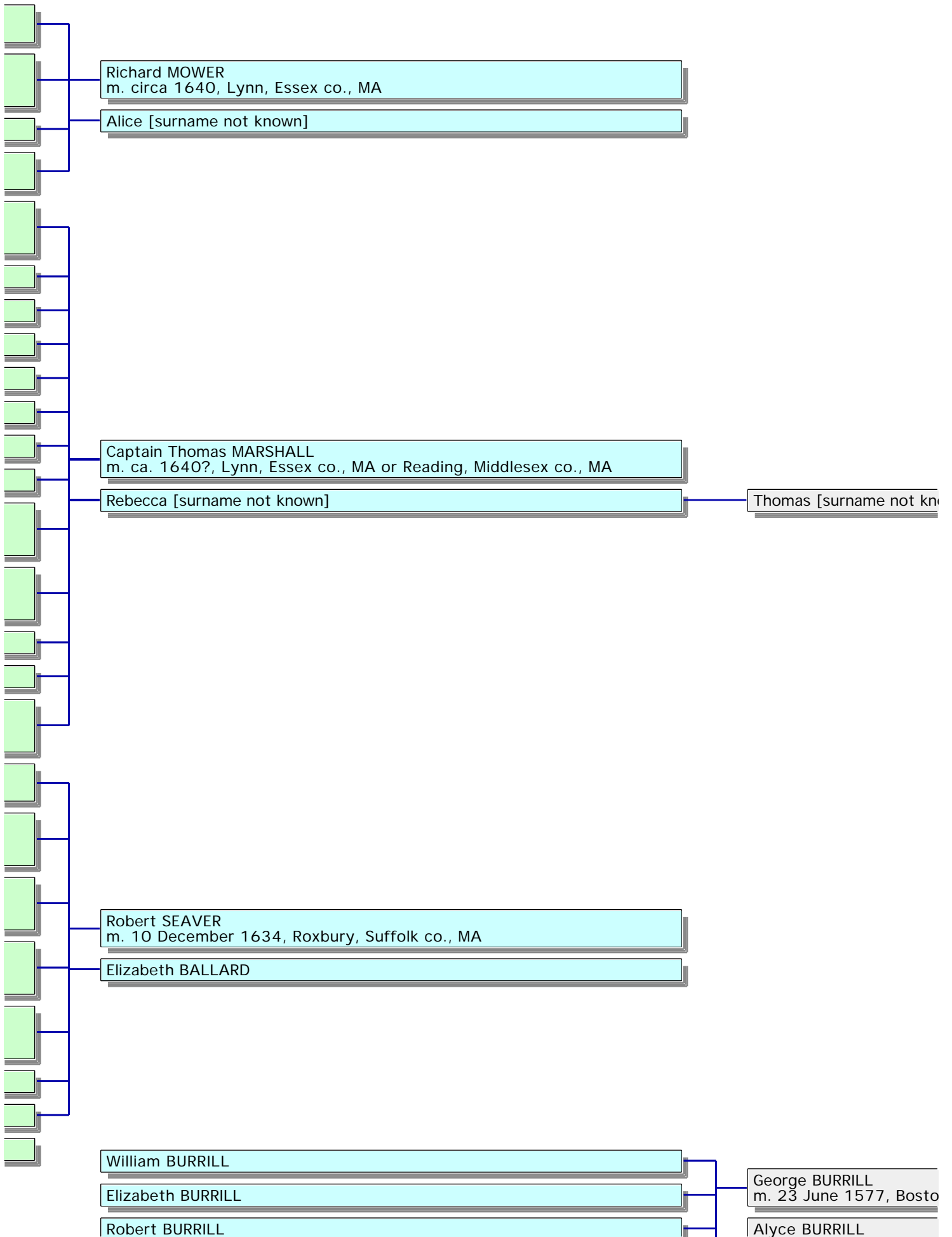

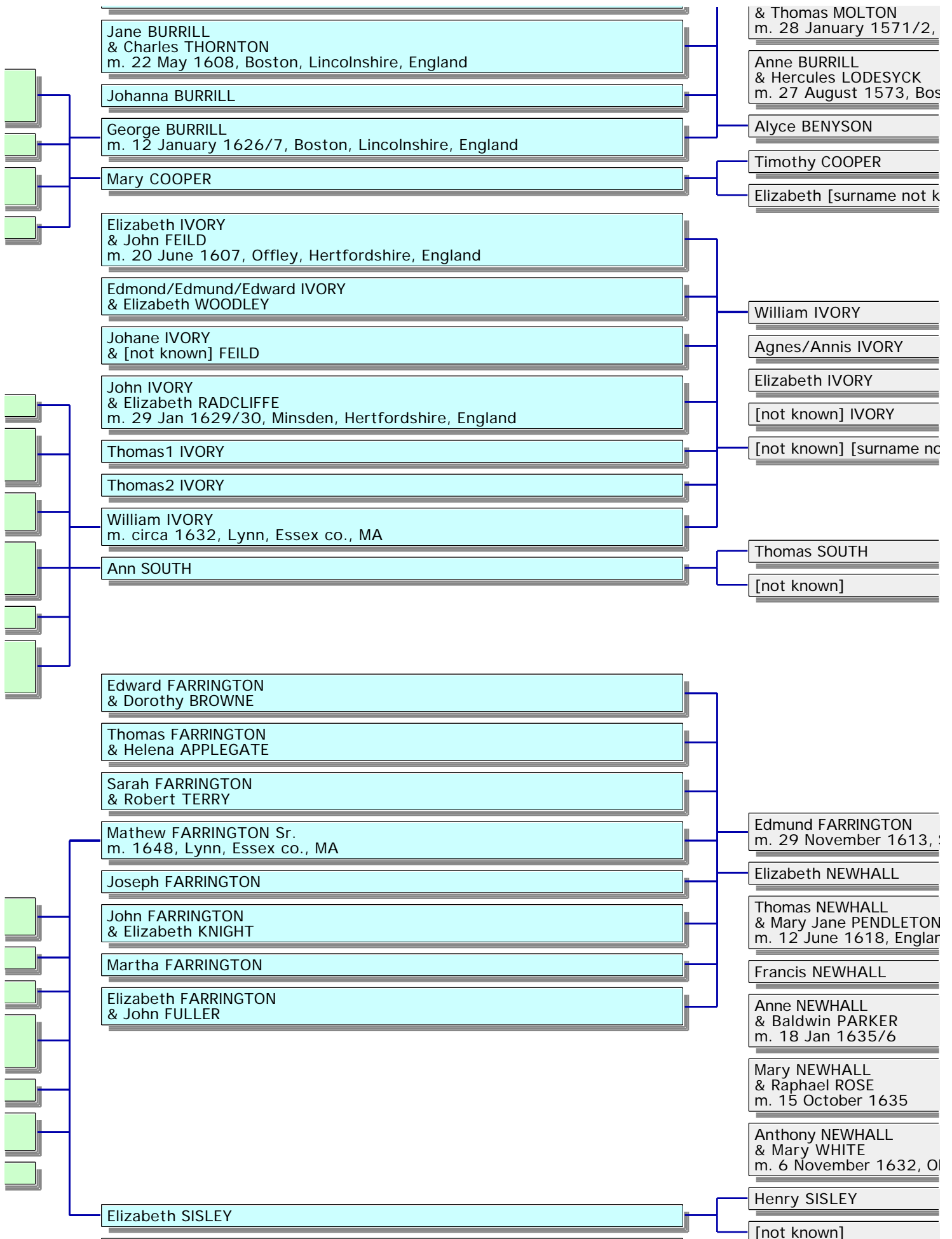

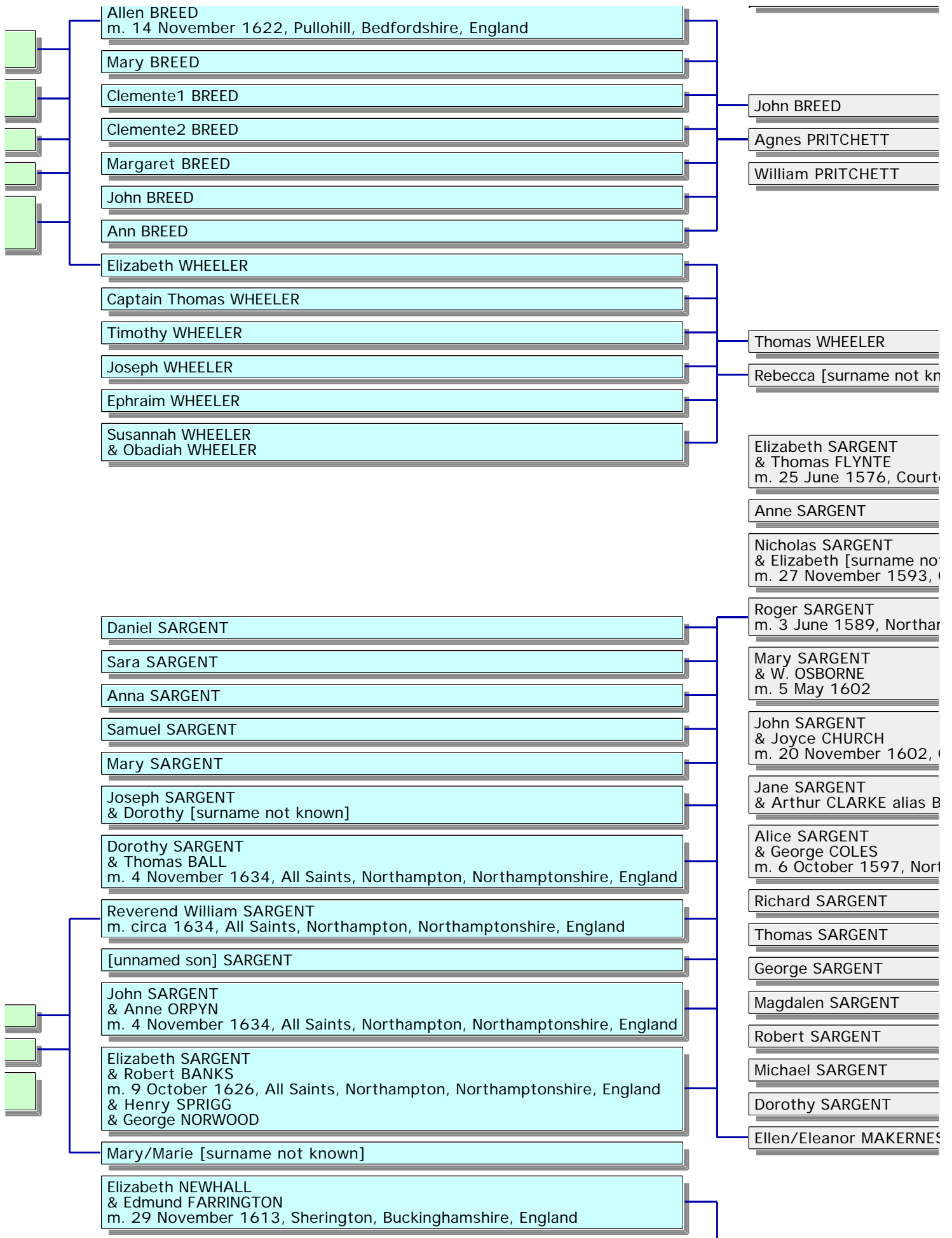

Thomas NEWHALL
& Mary Jane PENDLETON? WOOD? WOODARD?
m. 12 June 1618, England

Francis NEWHALL

Anne NEWHALL
& Baldwin PARKER
m. 18 Jan 1635/6

Mary NEWHALL
& Raphael ROSE
m. 15 October 1635

Anthony NEWHALL
m. 6 November 1632, Olney, England

Mary WHITE

[not known] NEWHALL

[not known]

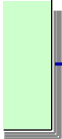

William BASSETT Sr.
m. by 1647, Lynn, Essex co., MA

Sarah [surname not known]

Roger BASSETT
m. 27 April 1623, Dorki

Ann HOLLAND

Richard HOOD Sr.
m. circa 1652, Lynn, Essex co., MA

Elizabeth NEWHALL
& Edmund FARRINGTON
m. 29 November 1613, :

Thomas NEWHALL
& Mary Jane PENDLETON
m. 12 June 1618, Englar

Francis NEWHALL

Anne NEWHALL
& Baldwin PARKER
m. 18 Jan 1635/6

Mary NEWHALL

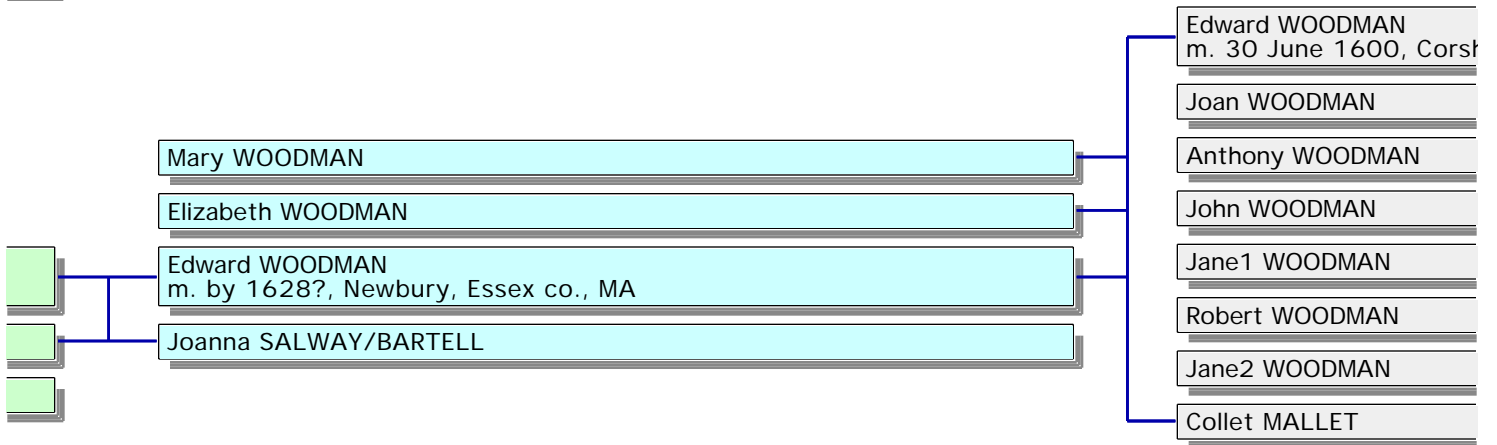
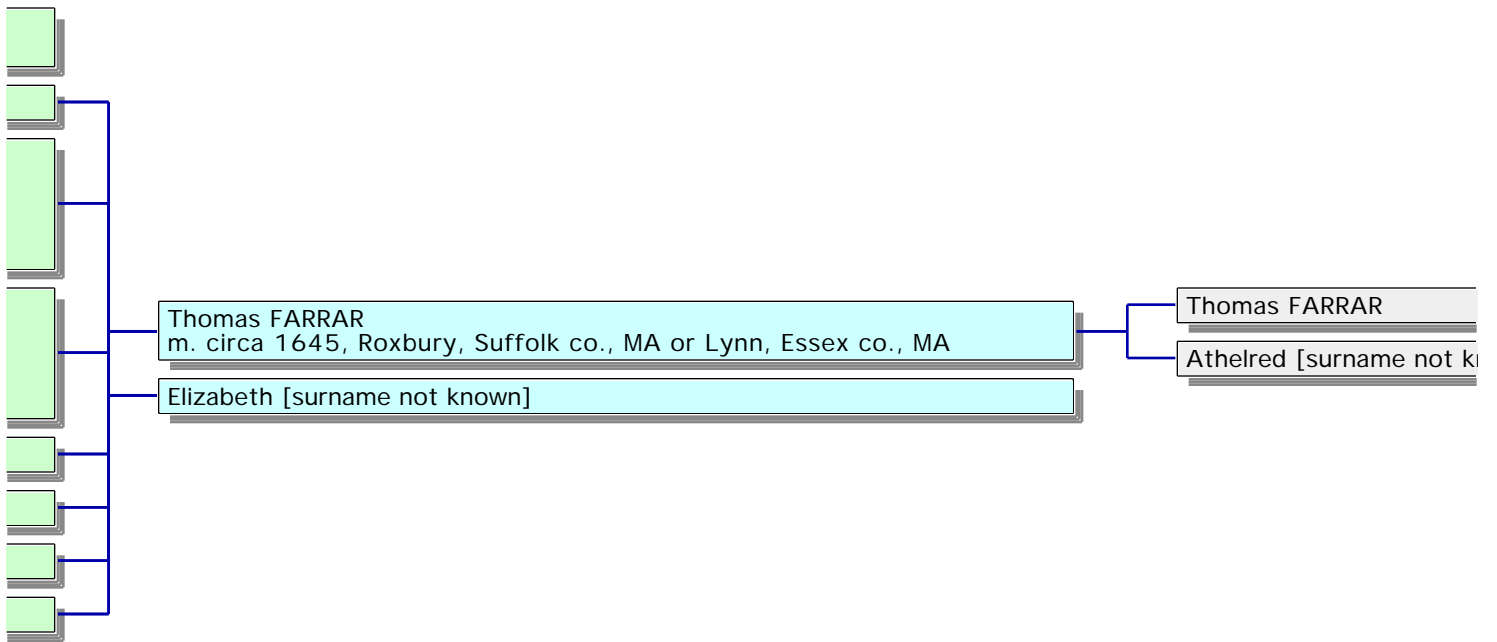
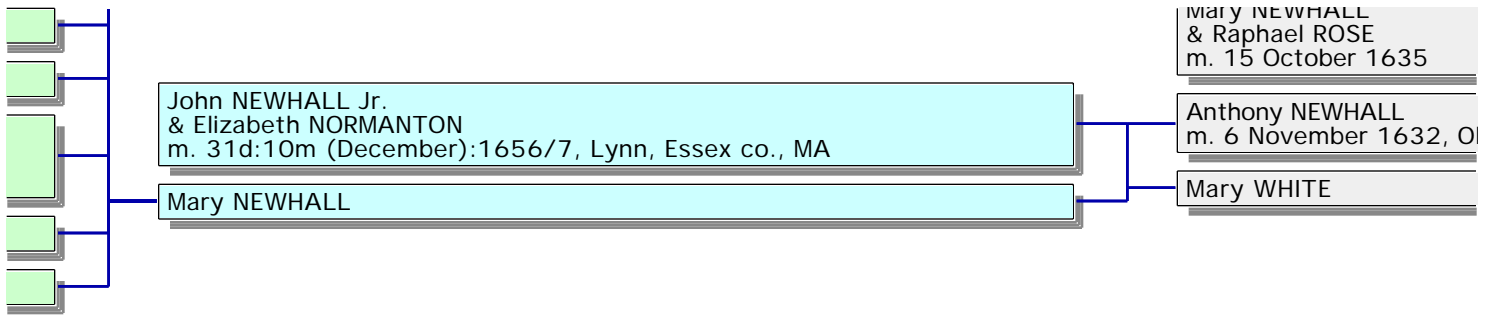

William SAWYER
m. circa 1643, Newbury, Essex co., MA or Durham, Strafford co., NH

Ruth BENFORD/BEDFIELD/BEDFORD/PERLEY

John EMERY Jr.
m. 29 October 1650, Newbury, Essex co., MA

Mary SHATSWELL

John SCALES
m. before 1649, Rowley, Essex co., MA

William SCALES
& Ann [surname not known]
& Susanna [surname not known]

Susannah [surname not known]

[not known] SCALES

Richard CURTIS

Sara [surname not known]

[Redacted]

[Redacted] not known]

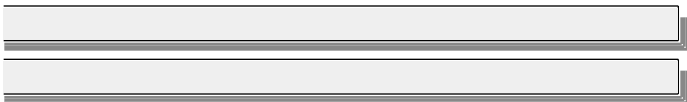
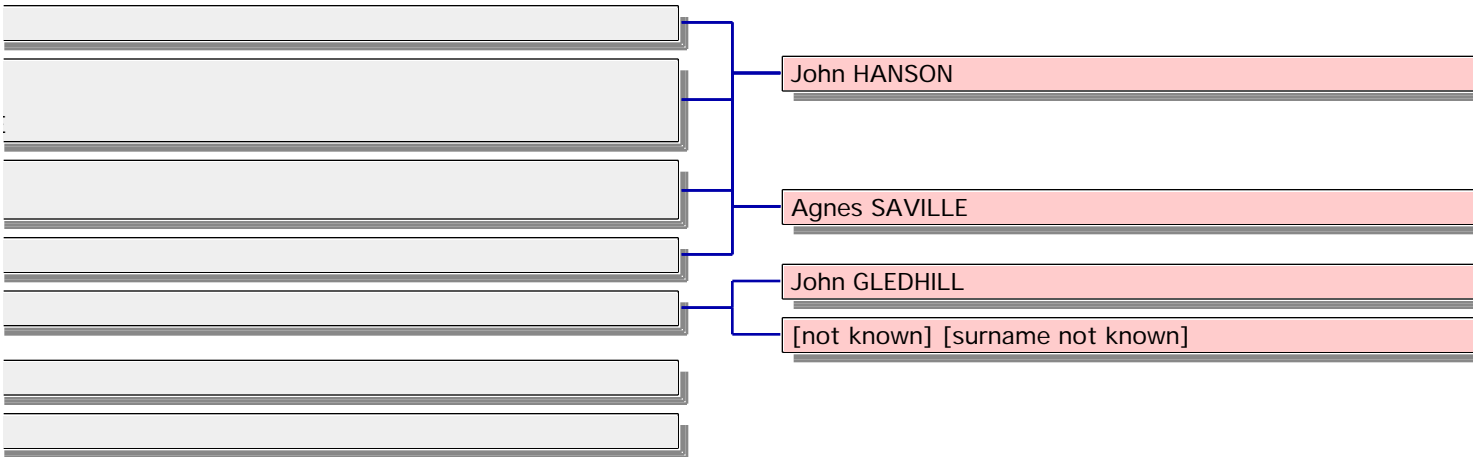

hall, Northamptonshire, England

Nicholas GIFFORD

Agnes MAISTER

HARNES

[Redacted]

[Redacted] not known]

[Redacted]

ewport-Pagnet, Buckinghamshire, England

Nicholas POTTER
[not known] [surname not known]

ewport-Pagnet, Buckinghamshire, England

Nicholas POTTER
[not known] [surname not known]

[not known]

known]

[not known]

[not known] LOCKWOOD

[not known] [surname not known]

, Ludgate, London, England

92, Fordington St. George, Upway, Dorsetshire, England

William WARREN

Alice [surname not known]

ERS

CK
wliscombe, Devonshire, England

wliscombe, Devonshire, England

not known]

not known]

Reverend Robert MAVERICK

[redacted]ombe, Devonshire, England

[redacted]

[redacted]ombe, Devonshire, England

[redacted]

[redacted]ERICK

[redacted]

[redacted]

[redacted]

[redacted]

[redacted]

[not known] [surname not known]

John GYE
m. 1509

Mary PROWSE

Thomas DOWRISH, Esquire

Anne FARRINGTON

CK
wliscombe, Devonshire, England

wliscombe, Devonshire, England

not known]

not known]

ombe, Devonshire, England

mbe, Devonshire, England

/ERICK

Reverend Robert MAVERICK

[not known] [surname not known]

John GYE
m. 1509

Mary PROWSE

Thomas DOWRISH, Esquire

Anne FARRINGTON

Robert COGSWELL

Alicia [surname not known]

England

IE
JE
n]

OMPSON,
vn]

Mansfield, Nottinghamshire, England

vn]

ot known]

St. Clement, Cambridge, Cambridgeshire, England

ot known]

Thomas WRIGHT
m. 2 June 1568, St. Edward, Cambridge, Cambridgeshire

Hellin ANSTER

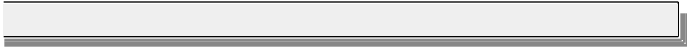

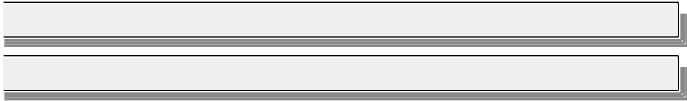

[Redacted]

[Redacted]

[Redacted]

[Redacted]

[Redacted]

[Redacted]

[Redacted]

[Redacted]

[Redacted]

[Redacted]

[Redacted]

[Redacted]

[Redacted]

[Redacted]

[Redacted]

[Redacted]

[Redacted]

[Redacted]

[Redacted]

[Redacted]

[Redacted]

[Redacted]

[Redacted]

[Redacted]

Thomas CUSHMAN
m. 18 July 1568, Rolvenden, co. Kent, England

Elinor HUBBARD

[Redacted]

[Redacted]

[Redacted]

[Redacted]

[Redacted]

[Redacted]

[Redacted]

[Redacted]

[Redacted]

[Redacted]

[Redacted]

[Redacted]

[Redacted]

[Redacted]

[Redacted]

[Redacted]

[Redacted]

[Redacted]

Edward ALLERTON
m. 14 Feb 1579/1580, England

Rose DAVIS

own]

n, Lincolnshire, England

[not known] RIRRI I

Boston, Lincolnshire, England
oston, Lincolnshire, England
nown]

[NOT KNOWN] BORNELL
Margaret [surname not known]

ot known]

Robert IVORY
Alice IVORY
Thomas IVORY
Richard IVORY
Elizabeth IVORY
Annys/Annis/Anne IVORY
William IVORY
Katherine/Katheryn [surname not known]

Sherington, Buckinghamshire, England
? WOOD? WOODARD?
d
ney, England

[not known] NEWHALL
[not known]



[not known] PRITCHETT

[not known]

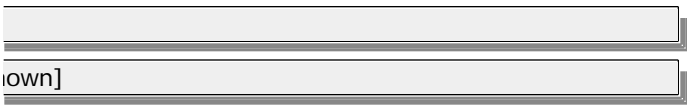

Hugh SARGENT
m. circa 1554, Courteenhall, Northamptonshire, England

Margaret GIFFORD

William MAKERNES/MACHARNES

Agnes HARRGAT

[Redacted]

ng, Surrey, England

Sherington, Buckinghamshire, England

? WOOD? WOODARD?
id

[not known] NEWHALL

[not known]

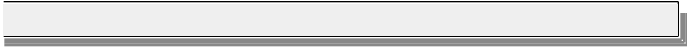

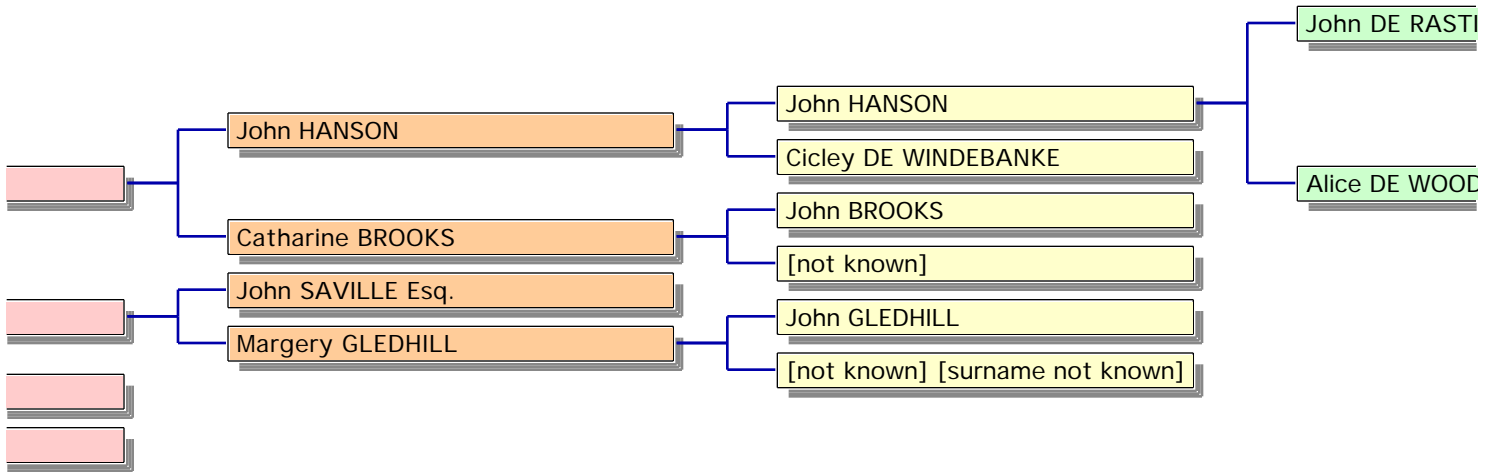

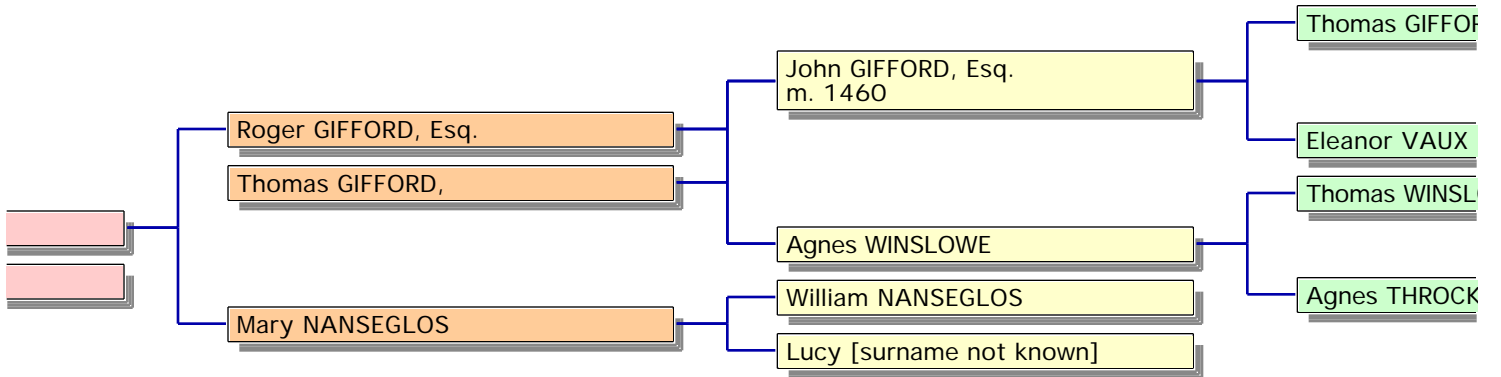

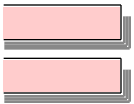
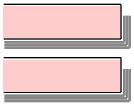



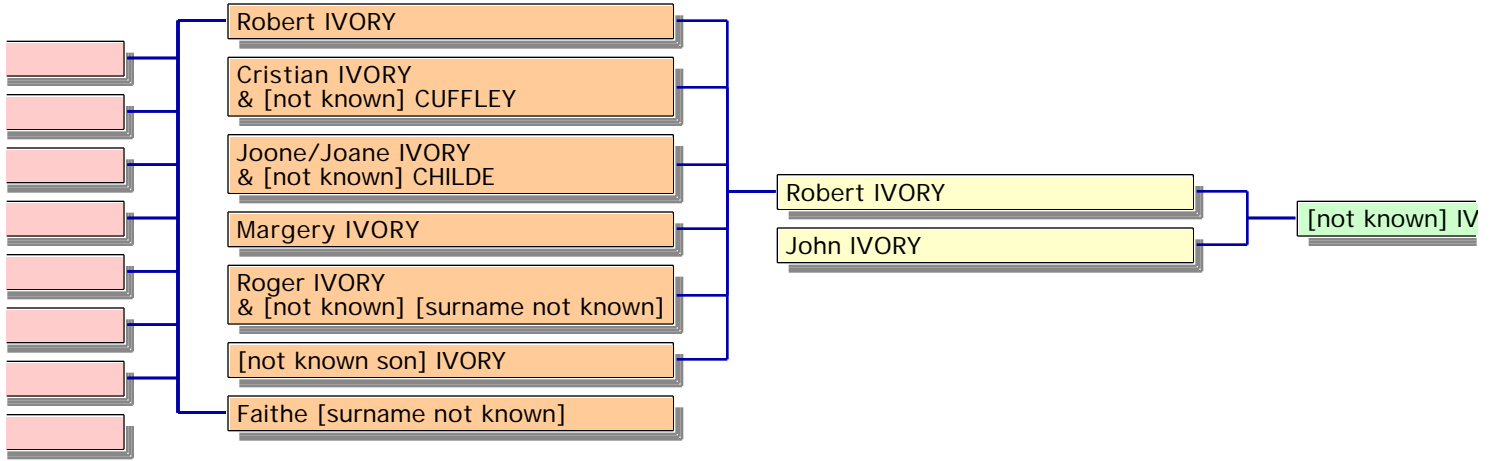



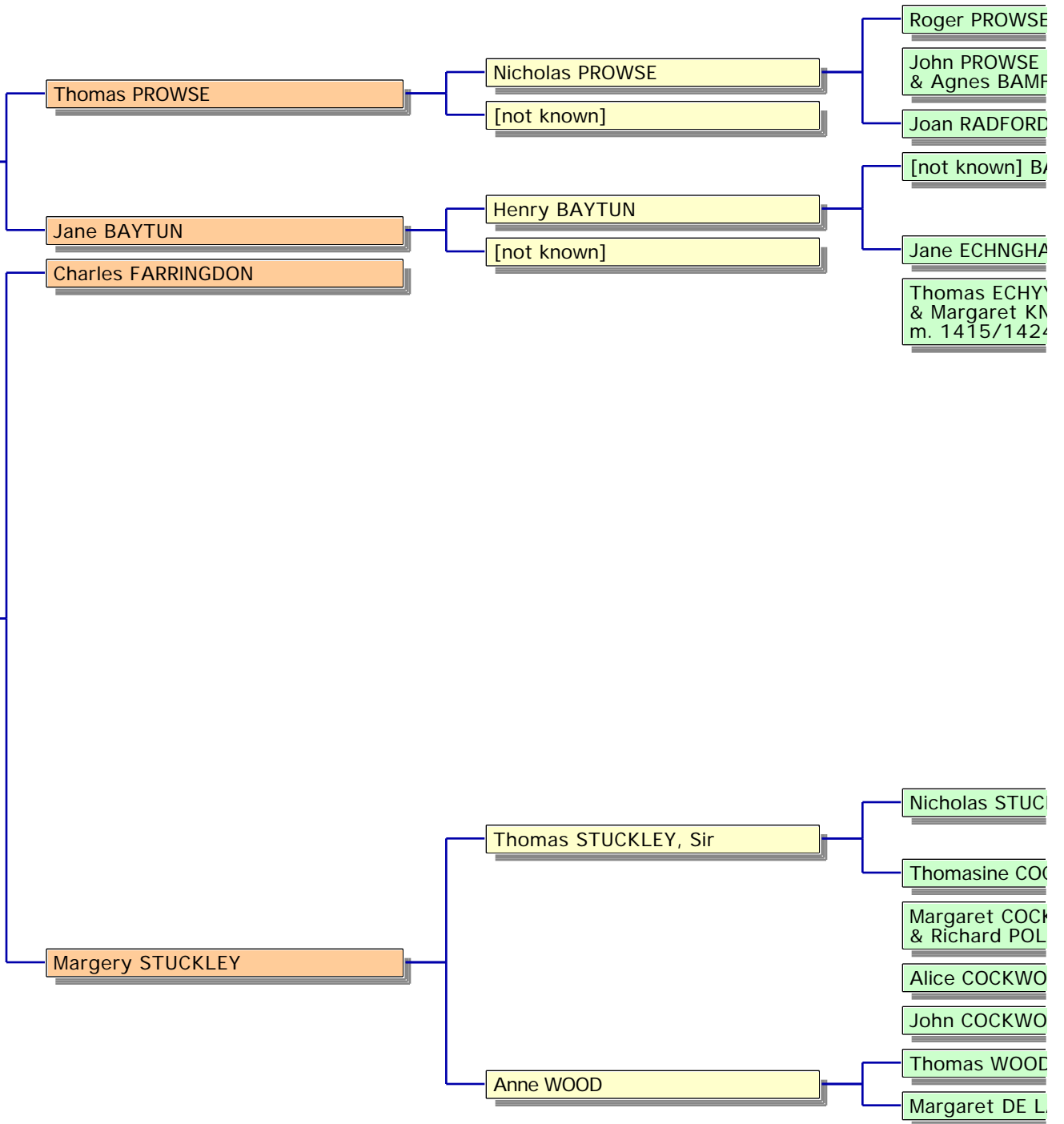

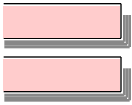

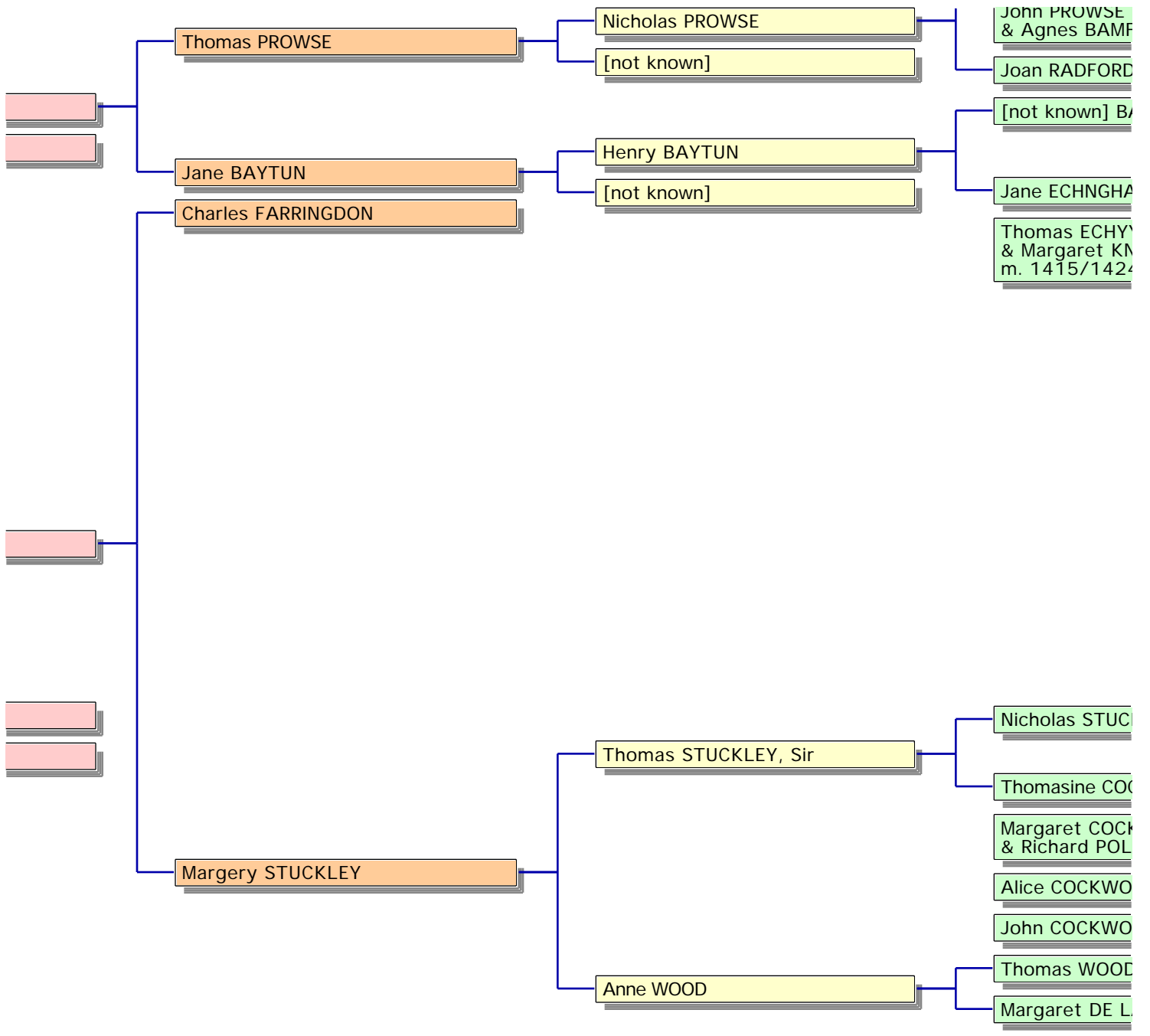

, England

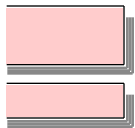
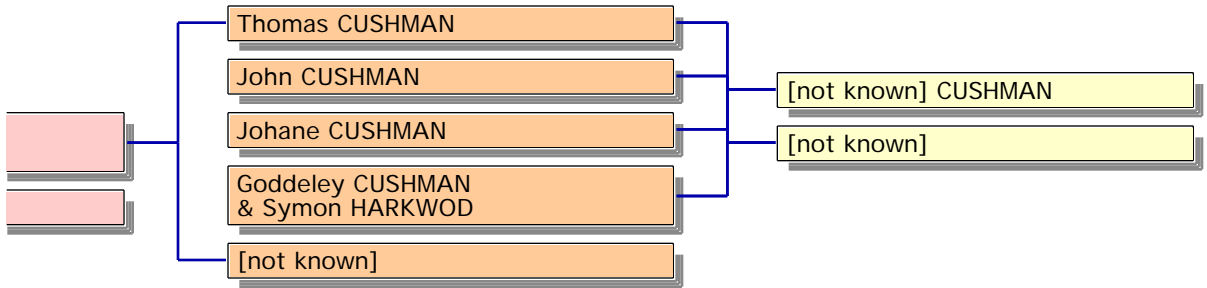

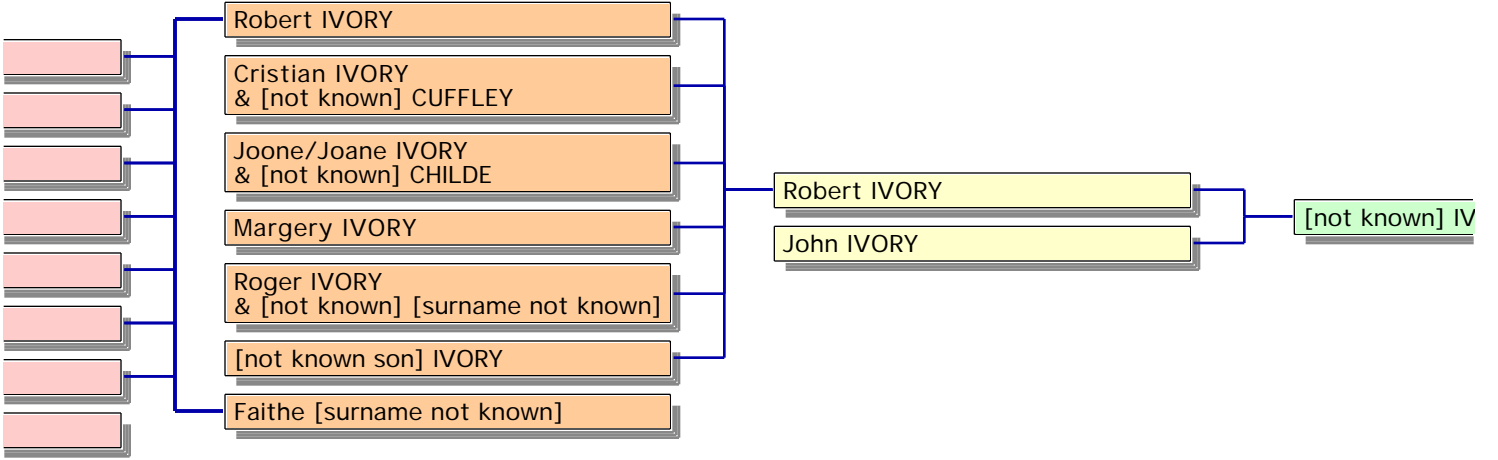
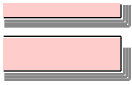

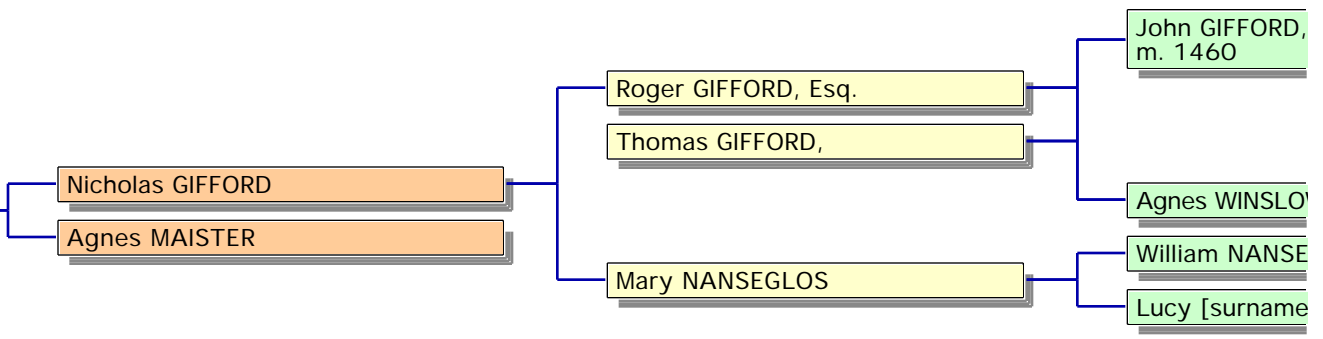
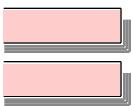
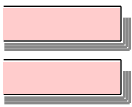

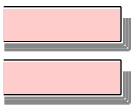

England

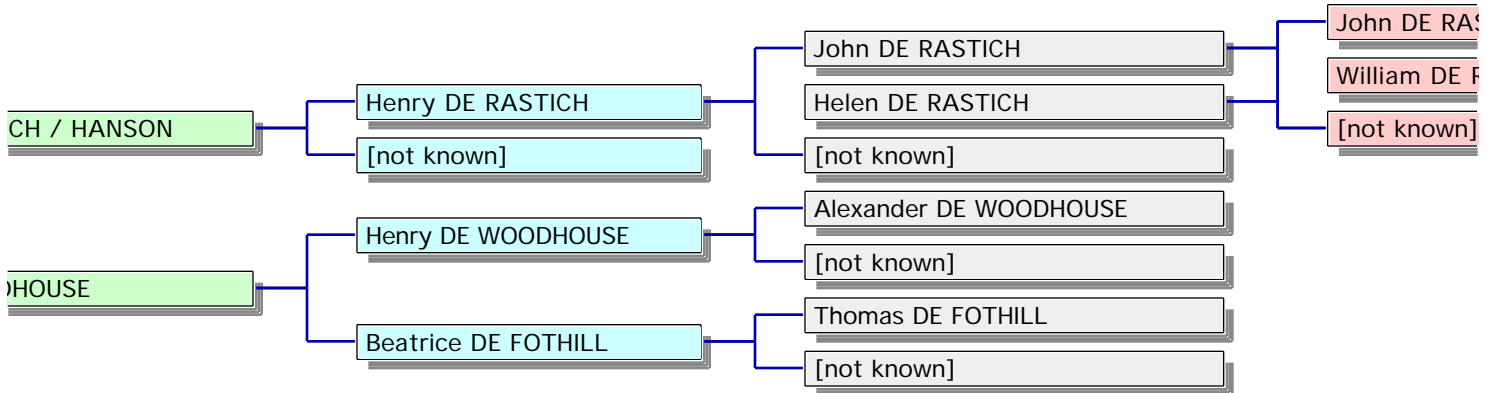

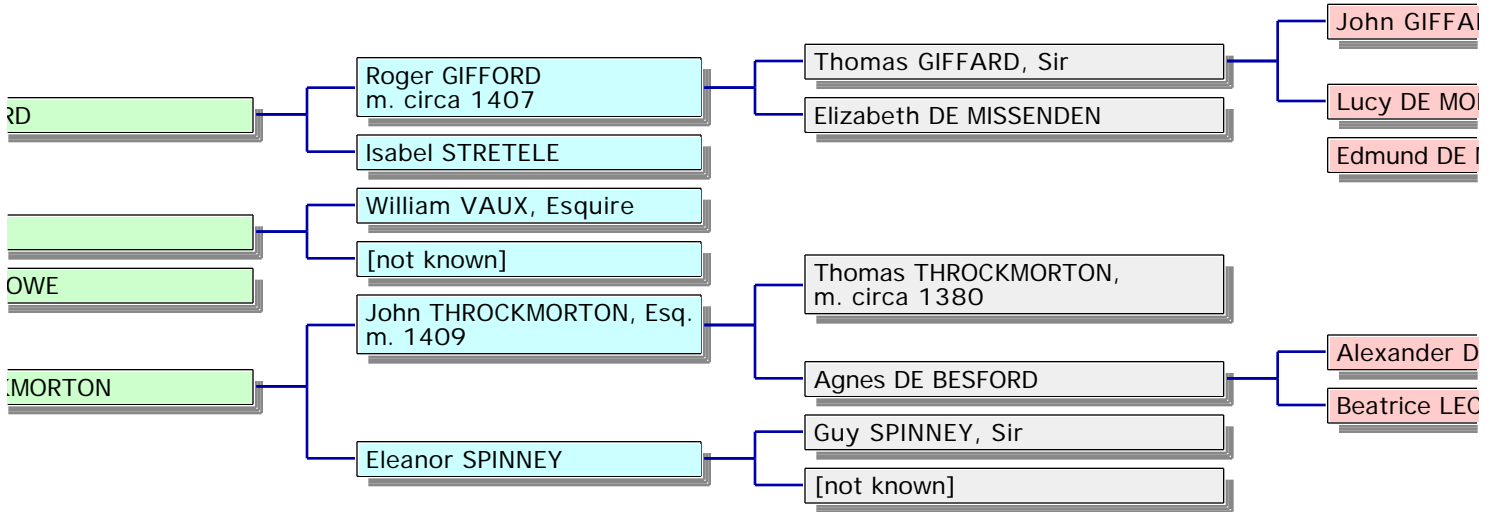

ORY

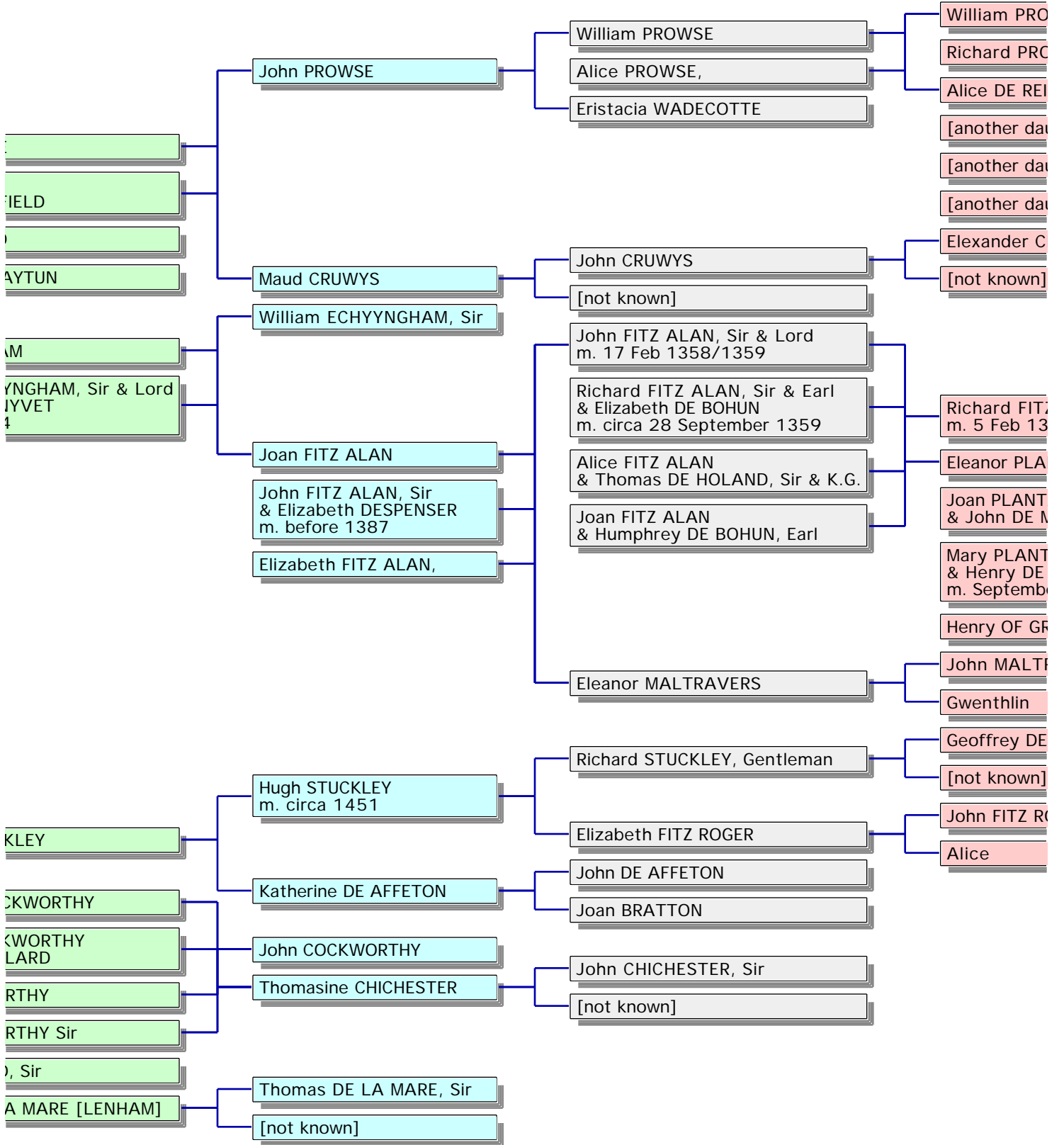

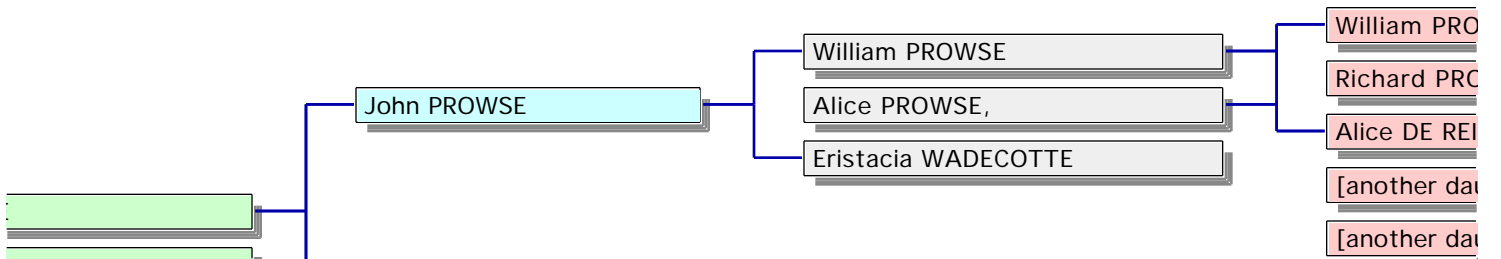

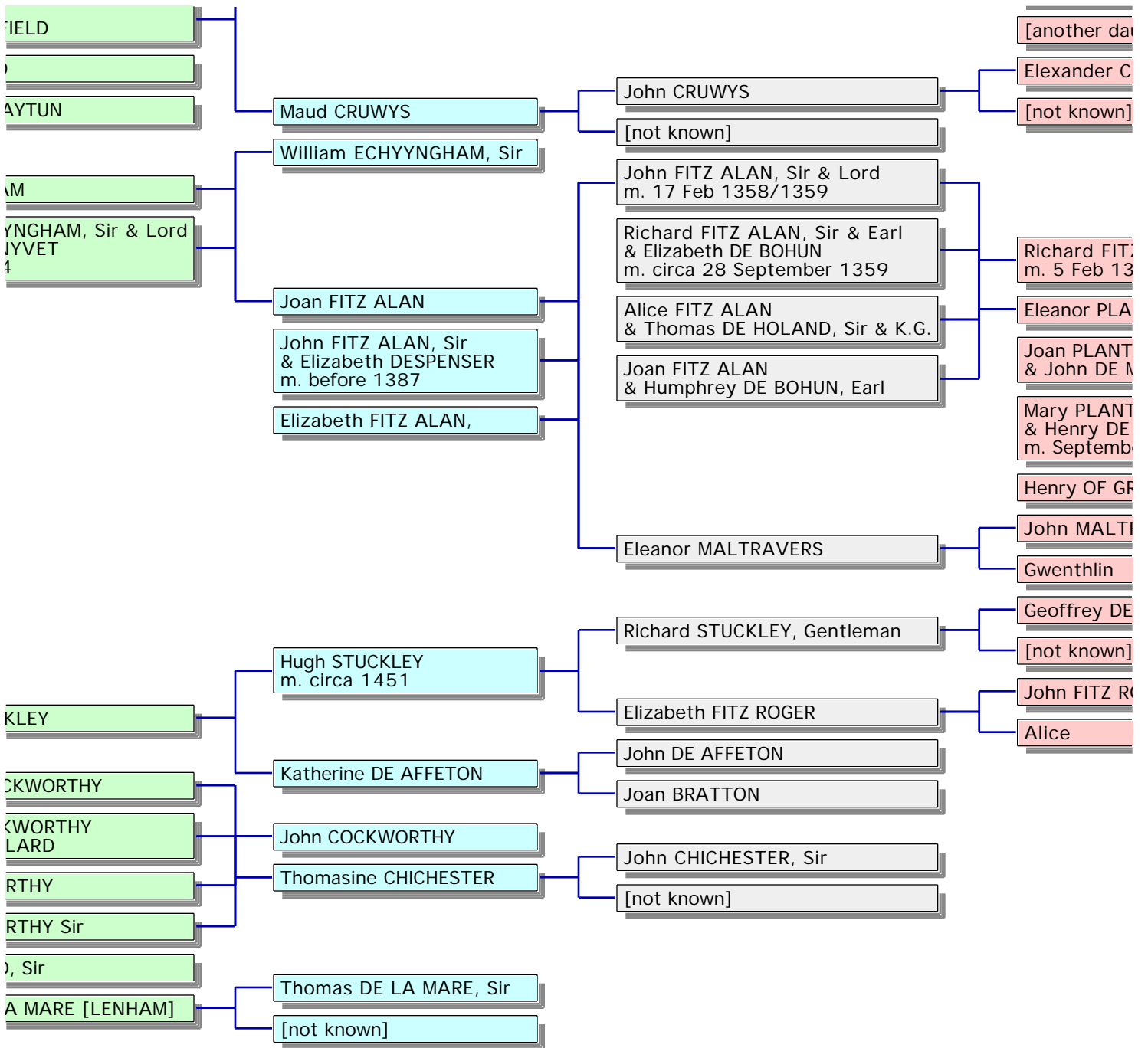

ORY

